

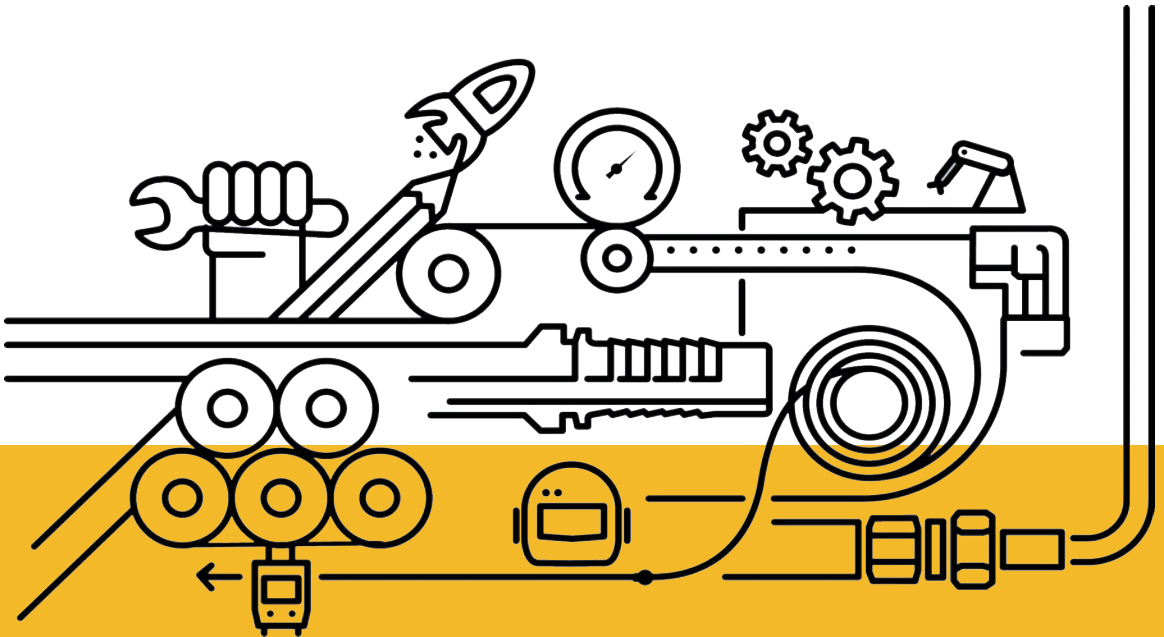

Vitillo

Hydraulic Components



Hoses



Press fittings ISO 12151 SAE J516



BSP adaptors BS 5200



JIC adaptors SAE J514



DIN 24° adaptors DIN 2353



ORFS adaptors ORFS J1453



Complete product range

Vitillo is your solution for any hydraulic applications. Spiral and braided hoses with metal and textile reinforcement, standard and interlock press fittings, BSP, JIC, DIN and ORFS adaptors, customized special fittings.

All our fittings and adapters are available in Zinc chromium III plating, Zinc-nichel plating and Stainless steel.

Whatever the customer's needs, Vitillo has the answer.

Alternative Versions

Zinc Chromium III



- Sealing Layer
- Passivation
- Zinc Cr III
- Carbon Steel

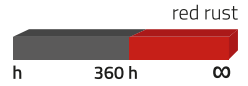
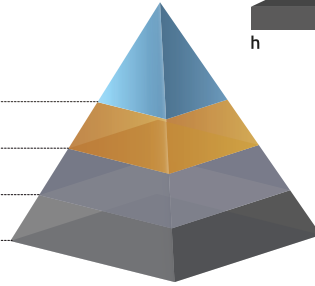

Zinc Nickel



- Sealing Layer
- Passivation
- Zinc Nickel
- Carbon Steel

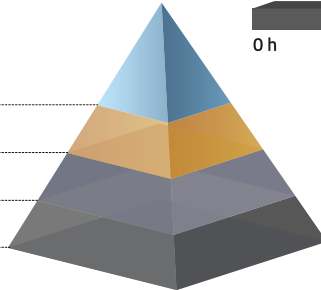

Stainless Steel



- Stainless Steel

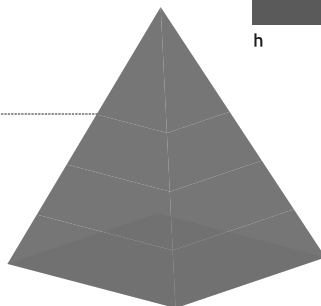



Applications



High performances in very extreme conditions



Certifications



▼
MINE SAFETY AND HEALTH
ADMINISTRATION
(MSHA)



▼
DET NORSKE VERITAS (DNV)
GERMANISCHER LLOYD (GL)



▼
RINA (Registro Navale Italiano)

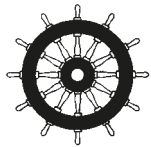

▼
MarED



▼
GOST-R



AC 149



▼
J.S. Hamilton Poland Sp. z.o.o. –
Jednostka Certyfikująca



▼
UNI EN 45545-2

COMPONENTS ORFS

ABO

BUSH
/ Pg. 14

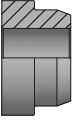

DBO

ORFS NUT
/ Pg. 15

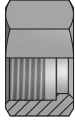

AMO

MALE ORFS - MALE ORFS
/ Pg. 16

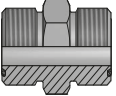

LMO

90° MALE EQUAL EL-
BOW-ORFS MALE
/ Pg. 17

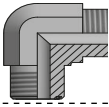

QMO

45° MALE ELBOW-ORFS
MALE
/ Pg. 18

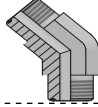

TMO

T ADPT MALE ORFS
/ Pg. 19

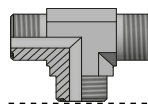

MALE-MALE ORFS

APPMO

BULKHEAD CONNECTION
/ Pg. 20

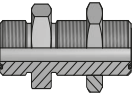

LPPMO

90° BULKHEAD-ORFS
MALE
/ Pg. 21

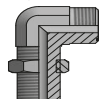

QPPMO

ORFS MALE BULKHEAD
ELBOW-ORFS MALE
/ Pg. 22

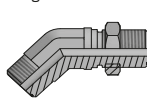

TPPMO. B

RUN TEE BULKHEAD MALE
ORFS / Pg. 23

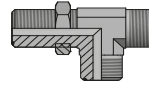

TPPMO. P

BRANCH TEE BULKHEAD
MALE ORFS / Pg. 24

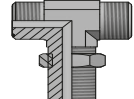

SWIVEL F.-MALE ORFS

AFGO MO

ADP SWIVEL FEMAL ORFS
- MALE ORFS
/ Pg. 25-26

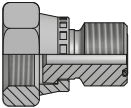

LMO. FGO

90° ADAPTOR FEMALE
ORFS-MALE ORFS
/ Pg. 27

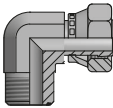

QMO.FGO

45° ADAPTOR FEMALE
ORFS -MALE ORFS
/ Pg. 28

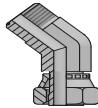

TMO FGO. B

RUN FEMALE ORFS-TEE
MALE ORFS
/ Pg. 29

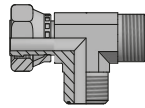

TMO FGO. P

BRANCH FEMALE ORFS-
TEE MALE ORFS
/ Pg. 30

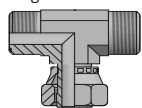

SWIVEL FEMALE ORFS

AFGO

FEMALE ORFS -FEMALE
ORFS
/ Pg. 31

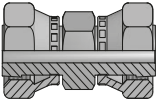

Visual index

MALE ORFS-MALE BSPP

AMO MG. R
ADP MALE ORFS MALE
BSPP FORM E
/ Pg. 32-33

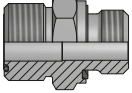

AMO MG. SV
ADP MALE ORFS MALE
BSPP 60° CONE
/ Pg. 34

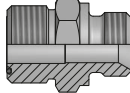

MALE ORFS-F. BSPP

AMO FFG
ADP MALE ORFS - FIXED
FEMALE BSPP
/ Pg. 35

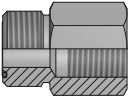

APPMO FFG
STRAIGHT BULKHEAD ADP
MALE ORFS-FEMALE BSPP
/ Pg. 36

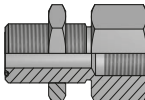

FEMALE ORFS-BSPP

AFGO FFG
ORFS SWIVEL NUT BSPP
FEMALE
/ Pg. 37

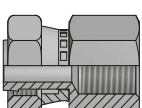

AFGO MG SV
ADP FEMALE ORFS MALE
BSPP WITH 60° CONE
/ Pg. 38

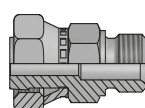

AFGO MG R
ADAPTOR FEMALE ORFS -
MALE BSPP FORM E
/ Pg. 39

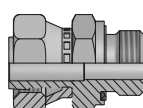

MALE ORFS-M. METRIC

AMO MM. R
ADP MALE ORFS MALE
METRIC FORM E
/ Pg. 40-41

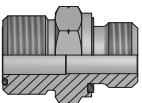

AMO MM
ADP MALE ORFS MALE
METRIC
/ Pg. 42

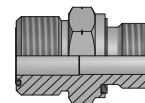

FEMALE ORFS-METRIC

AFGO FFM
ORFS SWIVEL NUT METRIC
FEMALE
/ Pg. 43

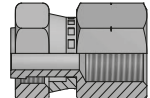

AFGO MM R
ADAPTOR FEMALE ORFS -
MALE METRIC FORM E
/ Pg. 44

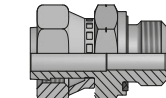

MALE ORFS-MALE UNF

AMO MU
ADP MALE ORFS MALE
UNF
/ Pg. 45-46

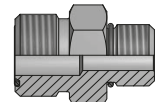

FEMALE ORFS-MALE UNF

AFGO MU
ADAPTOR FEMALE ORFS -
MALE UNF
/ Pg. 47

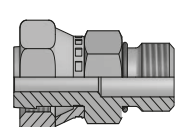

Visual index

MALE ORFS-MALE NPT

AMO MN

ADP MALE ORFS MALE NPT
/ Pg. 48

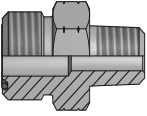

LMO MN

90° ADAPTOR MALE ORFS-
NPT MALE / Pg. 49

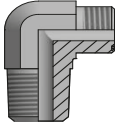

QMO MN

45° ADAPTOR MALE ORFS-
NPT MALE
/ Pg. 50

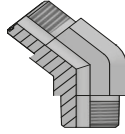

MALE ORFS-FEMALE NPT

AMO FFN

ADP MALE ORFS FIXED
FEMALE NPT
/ Pg. 51

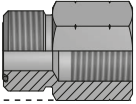

APPMO FFN

STRAIGHT BULKHEAD
MALE ORFS FEMALE NPT
/ Pg. 52

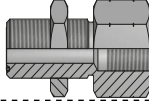

MALE ORFS-MALE DIN

AMO ME

ADP MALE ORFS
MALE DIN
/ Pg. 53

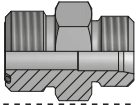

MALE ORFS-FEMALE DIN

AMO FE

ADP MALE ORFS
FEMALE DIN
/ Pg. 54

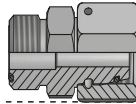

MALE ORFS-MALE JIC

AMO MJ

ADP MALE ORFS
MALE JIC
/ Pg. 55

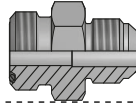

MALE ORFS-FEMALE JIC

AMO FGJ

ADP MALE ORFS
FEMALE JIC
/ Pg. 56

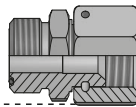

AFGO MJ

ADP FEMALE ORFS
MALE JIC
/ Pg. 57

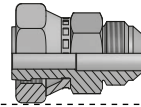

WELD FITTINGS

AMNST

WELDING ADP MALE ORFS
/ Pg. 58-59-60

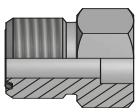

TO .. W

WELDING UNION
/ Pg. 61

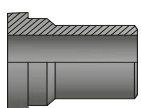

LMO .. W

90° ADP MALE ORFS SIDE
TO WELD
/ Pg. 62

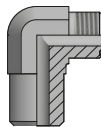

LMO .. T

90° ADP MALE ORFS SIDE
FEMALE TO WELD
/ Pg. 63

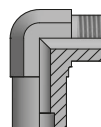

LMO MOG

90° ADJUSTABLE MALE
ORFS- MALE BSPP
/ Pg. 64-65

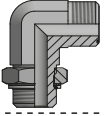

LMO MOM R

90° ADJUSTABLE MALE
ORFS- MALE METRIC
/ Pg. 66

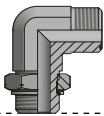

LMO MOU

90° ADJUSTABLE MALE
ORFS- MALE METRIC
/ Pg. 67-68

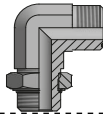

QMO MOG

45° ADJUSTABLE MALE
ORFS- MALE BSPP
/ Pg. 69-70

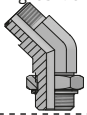

QMO MOM R

45° ADJUSTABLE MALE
ORFS- MALE METRIC
/ Pg. 71

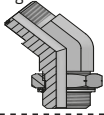

QMO MOU

45° ADJUSTABLE MALE
ORFS- MALE METRIC
/ Pg. 72-73

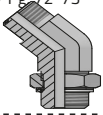

TMO MOG B

RUN TEE ADJUSTABLE
MALE ORFS- MALE BSPP
/ Pg. 74-75

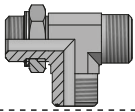

TMO MOM R B

RUN TEE ADJUSTABLE
MALE ORFS- MALE METRIC
/ Pg. 76

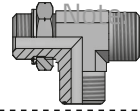

TMO MOU B

RUN TEE ADJUSTABLE
MALE ORFS- MALE METRIC
/ Pg. 77-78

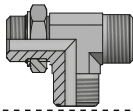

TMO MOG P

BRUNCH TEE ADJUSTABLE
MALE ORFS- MALE BSPP
/ Pg. 79-80

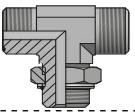

TMO MOM R P

BRUNCH TEE ADJUSTABLE
MALE ORFS- MALE METRIC
/ Pg. 81

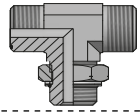

TMO MOU P

BRUNCH TEE ADJUSTABLE
MALE ORFS- MALE METRIC
/ Pg. 82-83

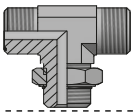

LOCKNUT ADJUSTABLE

LFGO MOG

90° FEMALE ORFS- AD-
JUSTABLE MALE BSPP
/ Pg. 84

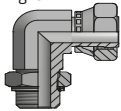

LFGO MOM R

90° FEMALE ORFS- AD-
JUSTABLE MALE METRIC
/ Pg. 85

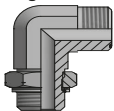

LFGO MOU

90° ADJUSTABLE MALE
ORFS- MALE METRIC
/ Pg. 86

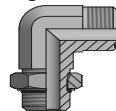

PLUG

ATMO

MALE PLUG UNF
/ Pg. 87

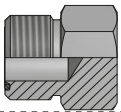

ATFGO

FEMALE PLUG UNF
/ Pg. 88

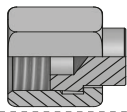

Note:

Vitillo Spa offers a wide range of fittings and adaptors. If you have not found here the threads combination you were looking for, please check also in the other catalogues or ask to our Technical Staff.

La Vitillo Spa offre una vasta gamma di raccordi e adattatori. Se non avete trovato qui la combinazione del filetto che stavate cercando, si prega di controllare anche negli altri cataloghi o chiedere al nostro staff tecnico.

Nut - Bush coupling correspondence

bush D	bush D	Bush CODE	NUT Code
6	1/4	ABO06	DBO06
8	5/16	ABO08	DBO09
10	3/8	ABO10	DBO09
12	1/2	ABO12	DBO11
14	-	ABO14	DBO13
15	-	ABO15	DBO13
16	5/8	ABO16	DBO13
18		ABO18	DBO14
20	3/4	ABO20	DBO14
22	7/8	ABO22	DBO15
25	1	ABO25	DBO15
28		ABO28	DBO21
30	1.1/4	ABO30	DBO21
32		ABO32	DBO21
35		ABO35	DBO32
38	1.1/2	ABO38	DBO32

BUSH FOR ORFS

BOCCOLA PER TUBO SVASATO
 MANCHON
 BÜCHSE
 CASQUILLO

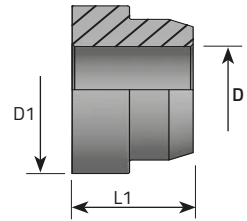

Code	Thread	Dimensions				Pressure
		D	D	D1	L1	
		in	mm	mm	mm	
AB006		1/4	6	12.75	7.5	
AB008		5/16	8	15.75	8.5	
AB010		3/8	10	15.75	8.5	
AB012		1/2	12	18.9	10.5	
AB014		-	14	23.45	10.5	
AB015		-	15	23.45	10.5	
AB016		5/8	16	23.45	10.5	
AB018			18	27.85	12	
AB020		3/4	20	27.85	12	
AB022		7/8	22	34.2	13.5	
AB025		1	25	34.2	13.5	
AB028		-	28	40.55	13	
AB030		1.1/4	30	40.55	13	
AB032		-	32	40.55	13	
AB035		-	35	48.5	12.5	
AB038		1.1/2	38	48.5	12.5	

ORFS NUT

DADO DI SERRAGGIO
ÉCROU ORFS
ORFS-MUTTER
TUERCA ORFS

F1 ORFS

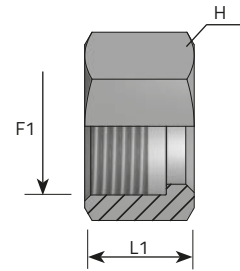

Code	Thread	Dimensions		Pressure
		H	L1	
	F1			
	in	mm	mm	
DB006	9/16"	17	15	
DB009	11/16"	22	17	
DB011	13/16"	24	20	
DB013	1"	30	24	
DB014	1.3/16"	36	26.5	
DB015	1.7/16"	41	27.5	
DB021	1.11/16"	50	27.5	
DB032	2"	60	27.5	

ADAPTOR MALE ORFS - MALE ORFS

ADATTATORE DIRITTO MASCHIO ORFS MASCHIO ORFS
 ADAPTATEUR MÂLE ORFS - MÂLE ORFS
 ADAPTER AG-ORFS/AG-ORFS
 ADAPTADOR MACHO ORFS - MACHO ORFS

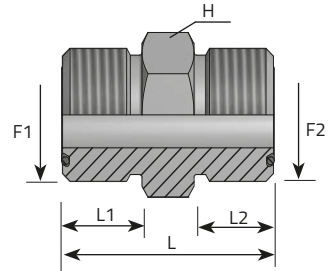

F1 ORFS

F2 ORFS

Code	Thread		Dimensions				Pressure	
	F1	F2	H	L1	L2	L	Bar	Psi
	in	in	mm	mm	mm	mm		
AMO0606	9/16	9/16	17	10	10	27.5	630	9136
AMO0909	11/16	11/16	19	11	11	31	630	9136
AMO1111	13/16	13/16	22	13	13	35.5	630	9136
AMO1313	1	1	27	15.5	15.5	42.5	420	6091
AMO1414	1.3/16	1.3/16	32	17	17	47	420	6091
AMO1515	1.7/16	1.7/16	41	17.5	17.5	49.5	420	6091
AMO2121	1.11/16	1.11/16	46	17.5	17.5	51.5	280	4060
AMO3232	2	2	55	17.5	17.5	53	280	4060
AMO0906	11/16	9/16	19	11	10	30	630	9136
AMO1109	13/16	11/16	22	13	11	33.5	630	9136
AMO1311	1	13/16	27	15.5	13	40	420	6091
AMO1409	1.3/16	11/16	32	17	11	41	420	6091
AMO1411	1.3/16	13/16	32	17	13	43	420	6091
AMO1413	1.3/16	1	32	17	15.5	45.5	420	6091
AMO1514	1.7/16	1.3/16	41	17.5	17	49	420	6091
AMO2115	1.11/16	1.7/16	46	17.5	17.5	51.5	280	4060

90° ADAPTOR MALE ORFS - MALE ORFS

GOMITO 90° MASCHIO ORFS MASCHIO ORFS
 ADAPTATEUR COUDE 90° MÂLE ORFS - MÂLE ORFS
 ADAPTER 90° GSK AG-ORFS/AG-ORFS
 CODO 90° MACHO ORFS - MACHO ORFS

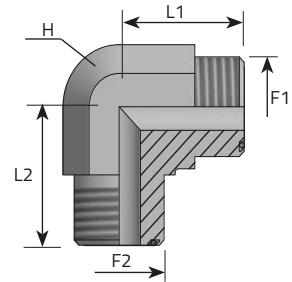

F1 ORFS

F2 ORFS

Code	Thread		Dimensions			Pressure	
	F1	F2	H	L1	L2	Bar	Psi
	in	in	mm	mm	mm		
LM00606	9/16	9/16	14	21.5	21.5	630	9136
LM00909	11/16	11/16	19	25	25	630	9136
LM01111	13/16	13/16	22	28	28	630	9136
LM01313	1	1	27	33.5	33.5	420	6091
LM01414	1.3/16	1.3/16	30	37.5	37.5	420	6091
LM01515	1.7/16	1.7/16	36	41.5	41.5	420	6091
LM02121	1.11/16	1.11/16	41	52	52	280	4060
LM03232	2	2	48	49	49	280	4060
LM00609	9/16	11/16	19	25	23.5	630	9136
LM00911	11/16	13/16	19	28	25	630	9136
LM01113	13/16	1	27	33.5	31.5	420	6091
LM00914	11/16	1.3/16	30	37.5	32.5	420	6091
LM01114	13/16	1.3/16	30	37.5	34.5	420	6091
LM01314	1	1.3/16	30	37.5	36.5	420	6091
LM01415	1.3/16	1.7/16	36	41.5	41	420	6091
LM01521	1.7/16	1.11/16	41	52	52	280	4060

45° ADAPTOR MALE ORFS - MALE ORFS

GOMITO 45° MASCHIO ORFS MASCHIO ORFS
 ADAPTATEUR COUDE 45° MÂLE ORFS - MÂLE ORFS
 ADAPTER 45° GSK AG-ORFS/AG-ORFS
 CODO 45° MACHO ORFS - MACHO ORFS

F1 ORFS

F2 ORFS

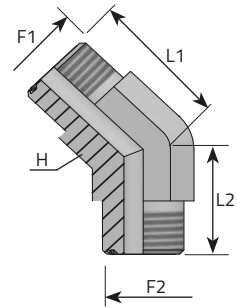

Code	Thread		Dimensions			Pressure	
	F1	F2	H	L1	L2	Bar	Psi
	in	in	mm	mm	mm		
QMO0606	9/16	9/16	14	16	16	630	9136
QMO0909	11/16	11/16	19	19	19	630	9136
QMO1111	13/16	13/16	22	20.5	20.5	630	9136
QMO1313	1	1	27	23.5	23.5	420	6091
QMO1414	1.3/16	1.3/16	30	26	26	420	6091
QMO1515	1.7/16	1.7/16	36	30	30	420	6091
QMO2121	1.11/16	1.11/16	41	32	32	280	4060
QMO3232	2	2	48	37	37	280	4060

TEE ADAPTOR MALE ORFS

ADATTATORE A T MASCHIO ORFS MASCHIO ORFS
 ADAPTATEUR TÊ MÂLE ORFS
 ADAPTER T-STUCK 3 X AG-ORFS
 ADAPTADOR TE MACHO ORFS

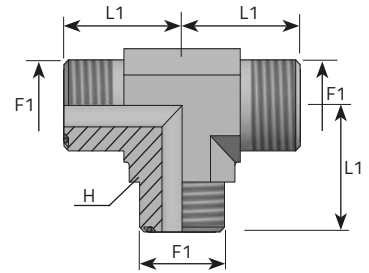

F1 ORFS

Code	Thread	Dimensions		Pressure	
		H	L1	Bar	Psi
	F1				
	in	mm	mm		
TM00606	9/16	14	21.5	630	9136
TM00909	11/16	19	25	630	9136
TM01111	13/16	22	28	630	9136
TM01313	1	27	33.5	420	6091
TM01414	1.3/16	30	37.5	420	6091
TM01515	1.7/16	36	41.5	420	6091
TM02121	1.11/16	41	44.5	280	4060
TM03232	2	48	49	280	4060

STRAIGHT BULKHEAD ADAPTOR MALE ORFS

ADATTATORE PASSAPARETE MASCHIO ORFS
 PASSE-CLOISON MÂLE ORFS
 SCHOTTADAPTER AG-ORFS
 PASATABIQUE MACHO ORFS

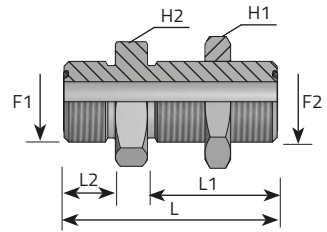

F1 ORFS

F2 ORFS

Code	Thread		Dimensions					Pressure	
	F1	F2	H	H1	L2	L1	L	Bar	Psi
	in	in	mm	mm	mm	mm	mm		
APPMO0606	9/16	9/16	22	22	31.5	10	48	630	9136
APPMO0909	11/16	11/16	27	27	34	11	53	630	9136
APPMO1111	13/16	13/16	30	30	36.5	13	58,5	630	9136
APPMO1313	1	1	36	36	40.5	15.5	66,5	420	6091
APPMO1414	1.3/16	1.3/16	41	41	41.5	17	69	420	6091
APPMO1515	1.7/16	1.7/16	46	46	42	17.5	70	280	4060
APPMO2121	1.11/16	1.11/16	50	50	42	17.5	70	280	4060
APPMO3232	2	2	60	60	42	17.5	70	280	4060

90° BULKHEAD ADAPTOR MALE ORFS - MALE ORFS

GOMITO 90° PASSAPARETE MASCHIO ORFS MASCHIO ORFS
 PASSE-CLOISON COUDE 90° MÂLE ORFS - MÂLE ORFS
 ADAPTER 90° GSK-SCHOTTADAPTER AG-ORFS - AG-ORFS
 PASATABIQUE CODO 90° MACHO ORFS - MACHO ORFS

F1 ORFS

F2 ORFS

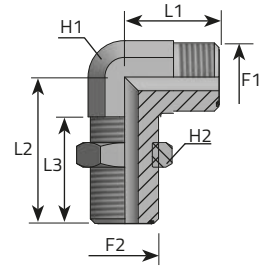

Code	Thread		Dimensions						Pressure	
	F1	F2	H1	H2	L1	L2	L3	Bar	Psi	
	in	in	mm	mm	mm	mm	mm			
LPPMO0606	9/16	9/16	14	22	21.5	47	31.5	630	9136	
LPPMO0909	11/16	11/16	19	27	25	52	34	630	9136	
LPPMO1111	13/16	13/16	22	30	28	55.5	36.5	630	9136	
LPPMO1313	1	1	27	36	33.5	63	40.5	420	6091	
LPPMO1414	1.3/16	1.3/16	33	41	42	67	41.5	420	6091	
LPPMO1515	1.7/16	1.7/16	36	46	45.5	75	43	420	6091	
LPPMO2121	1.11/16	1.11/16	41	50	52	75.5	42	280	4060	
LPPMO3232	2	2	48	60	49	79.5	42	280	4060	

45° BULKHEAD ADAPTOR MALE ORFS - MALE ORFS

GOMITO 45° PASSAPARETE MASCHIO ORFS MASCHIO ORFS
 PASSE-CLOISON COUDE 45° MÂLE ORFS - MÂLE ORFS
 ADAPTER 45° GSK-SCHOTTADAPTER AG-ORFS - AG-ORFS
 PASATABIQUE CODO 45° MACHO ORFS - MACHO ORFS

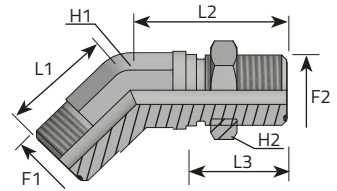

F1 ORFS

F2 ORFS

Code	Thread		Dimensions						Pressure	
	F1	F2	H1	H2	L1	L2	L3	Bar	Psi	
	in	in	mm	mm	mm	mm	mm			
QPPMO0606	9/16	9/16	14	22	16	44	31.5	630	9136	
QPPMO0909	11/16	11/16	19	27	19	48.5	34	630	9136	
QPPMO1111	13/16	13/16	22	30	20.5	51	36.5	630	9136	
QPPMO1313	1	1	27	36	23.5	56.5	40.5	420	6091	
QPPMO1414	1.3/16	1.3/16	30	41	26	60.5	41.5	420	6091	
QPPMO1515	1.7/16	1.7/16	36	46	30	65	42	420	6091	
QPPMO2121	1.11/16	1.11/16	41	50	32	67	42	280	4060	
QPPMO3232	2	2	48	60	37	67	42	280	4060	

RUN TEE BULKHEAD ADAPTOR MALE ORFS - MALE ORFS

T PASSAPARETE AL BRACCIO MASCHIO ORFS MASCHIO ORFS
 PASSE-CLOISON TÊ MÂLE ORFS - MÂLE ORFS
 SCHOTTADAPTER T-STUCK AG-ORSF / AG-ORFS
 PASATABIQUE TE MACHO ORFS - MACHO ORFS

F1 ORFS

F2 ORFS

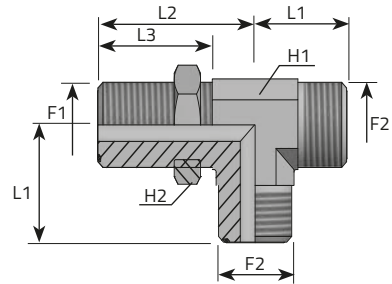

Code	Thread		Dimensions						Pressure	
	F1	F2	H1	H2	L1	L2	L3	Bar	Psi	
	in	in	mm	mm	mm	mm	mm			
TPPMO0606B	9/16	9/16	14	22	21.5	47	31.5	630	9136	
TPPMO0909B	11/16	11/16	19	27	25	52	34	630	9136	
TPPMO1111B	13/16	13/16	22	30	28	55.5	36.5	630	9136	
TPPMO1313B	1	1	27	36	33.5	63	40.5	420	6091	
TPPMO1414B	1.3/16	1.3/16	30	41	37.5	67	41.5	420	6091	
TPPMO1515B	1.7/16	1.7/16	36	46	41.5	71	42	420	6091	
TPPMO2121B	1.11/16	1.11/16	41	50	44.5	75.5	42	280	4060	
TPPMO3232B	2	2	48	60	49	79.5	42	280	4060	

BRANCH TEE BULKHEAD ADAPTOR MALE ORFS - MALE ORFS

T PASSAPARETE AL PIEDE MASCHIO ORFS MASCHIO ORFS
 PASSE-CLOISON TÉ MÂLE ORFS - MÂLE ORFS
 SCHOTTADAPTER T-STUCK 2 X AG-ORSF / 1 X AG-ORSF
 PASATABIQUE TE MACHO ORFS - MACHO ORFS

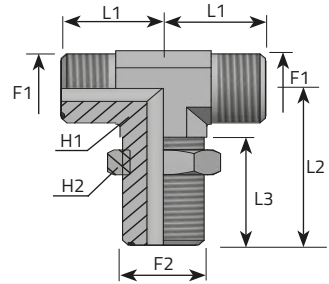

F1 ORFS

F2 ORFS

Code	Thread		Dimensions					Pressure	
	F1	F2	H1	H2	L1	L2	L3	Bar	Psi
	in	in	mm	mm	mm	mm	mm		
TPPM00606P	9/16	9/16	14	22	21.5	47	31.5	630	9136
TPPM00909P	11/16	11/16	19	27	25	52	34	630	9136
TPPM01111P	13/16	13/16	22	30	28	55.5	36.5	630	9136
TPPM01313P	1	1	27	36	33.5	63	40.5	420	6091
TPPM01414P	1.3/16	1.3/16	30	41	37.5	67	41.5	420	6091
TPPM01515P	1.7/16	1.7/16	36	46	41.5	71	42	420	6091
TPPM02121P	1.11/16	1.11/16	41	50	44.5	75.5	42	280	4060
TPPM03232P	2	2	48	60	49	79.5	42	280	4060

ADAPTOR SWIVEL FEMALE ORFS- MALE ORFS (1)

RIDUZIONE DIRITTA FEMMINA GIREVOLE ORFS MASCHIO ORFS
 ADAPTATEUR FEMELLE TOURNANTE ORFS - MÂLE ORFS
 REDUZIERUNG IG-ORFS / AG - ORFS
 ADAPTADOR HEMBRA GIRATORIA ORFS - MACHO ORFS

F1 ORFS

F2 ORFS

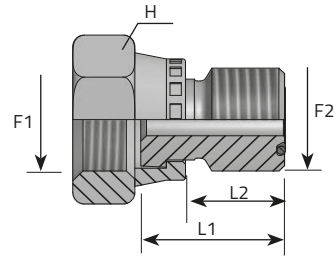

Code	Thread		Dimensions			Pressure		
	F1	F2	H	L1	L2	form	Bar	Psi
	in	in	mm	mm	mm			
AFGO09M006	11/16	9/16	22	20	10	X	630	9136
AFGO11M006	13/16	9/16	24	22	10	Y	630	9136
AFGO13M006	1	9/16	30	23	10	Y	420	6091
AFGO14M006	1.3/16	9/16	36	25	10	Y	420	6091
AFGO15M006	1.7/16	9/16	41	26	10	Y	420	6091
AFGO21M006	1.11/16	9/16	50	26.5	10	Y	280	4060
AFGO32M006	2	9/16	60	26.5	10	Y	280	4060
AFGO11M009	13/16	11/16	24	23	11	X	630	9136
AFGO13M009	1	11/16	30	24	11	Y	420	6091
AFGO14M009	1.3/16	11/16	36	26	11	Y	420	6091
AFGO15M009	1.7/16	11/16	41	27	11	Y	420	6091
AFGO21M009	1.11/16	11/16	50	27.5	11	Y	280	4060
AFGO32M009	2	11/16	60	27.5	11	Y	280	4060

X: Version with crimped nut

Versione con dado pressato

Y: Version with slip back nut

Versione con dado sfilabile

ADAPTOR SWIVEL FEMALE ORFS- MALE ORFS (2)

RIDUZIONE DIRITTA FEMMINA GIREVOLE ORFS MASCHIO ORFS
 ADAPTATEUR FEMELLE TOURNANTE ORFS - MÂLE ORFS
 REDUZIERUNG IG-ORFS / AG - ORFS
 ADAPTADOR HEMBRA GIRATORIA ORFS - MACHO ORFS

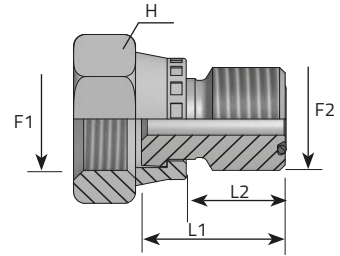

F1 ORFS

F2 ORFS

Code	Thread		Dimensions			Pressure		
	F1	F2	H	L1	L2	form	Bar	Psi
	in	in	mm	mm	mm			
AFGO13MO11	1	13/16	30	25.5	13	Y	420	6091
AFGO14MO11	1.3/16	13/16	36	27.5	13	Y	420	6091
* AFGO14MO15	1.3/16	1.7/16	36	58	17.5	z	420	6091
AFGO15MO11	1.7/16	13/16	41	29	13	Y	420	6091
* AFGO15MO21	1.7/16	1.11/16	41	60.5	17.5	z	420	6091
AFGO21MO11	1.11/16	13/16	50	29.5	13	Y	280	4060
AFGO32MO11	2	13/16	60	29.5	13	Y	280	4060
AFGO14MO13	1.3/16	1	36	29.5	15.5	X	420	6091
AFGO14MO15	1.3/16	1.7/16	41	32	17.5	X	420	6091
AFGO15MO13	1.7/16	1	41	32	15.5	Y	420	6091
AFGO15MO21	1.7/16	1.11/16	46	33.5	17.5	X	420	6091
AFGO21MO13	1.11/16	1	50	32	15.5	Y	280	4060
AFGO32MO13	2	1	60	32	15.5	Y	280	4060
AFGO15MO14	1.7/16	1.3/16	41	33	17	Y	420	6091
AFGO21MO14	1.11/16	1.3/16	50	33.5	17	Y	280	4060
AFGO32MO14	2	1.3/16	60	33.5	17	Y	280	4060
AFGO21MO15	1.11/16	1.7/16	50	34	17.5	X	280	4060
AFGO32MO15	2	1.7/16	60	34	17.5	Y	280	4060
AFGO32MO21	2	1.11/16	60	34	17.5	Y	280	4060

X: Version with crimped nut

Versione con dado pressato

Y: Version with slip back nut

Versione con dado sfilabile

Z: Double hexagon version

Versione con doppio esagono

90° ADAPTOR FEMALE ORFS – MALE ORFS

GOMITO A 90° FEMMINA ORFS DADO PRESSATO MASCHIO ORFS
 ADAPTATEUR COUDE 90° FEMELLE ORFS – MÂLE ORFS
 ADAPTER 90° IG-ORFS / AG -ORFS
 CODO 90° HEMBRA ORFS – MACHO ORFS

F1 ORFS

F2 ORFS

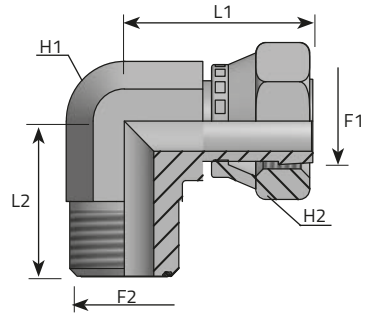

Code	Thread		Dimensions				Pressure	
	F1	F2	H1	H2	L1	L2	Bar	Psi
	in	in	mm	mm	mm	mm		
LMO06FG006	9/16	9/16	14	17	26.5	21.5	420	6091
LMO09FG009	11/16	11/16	19	22	29	25	420	6091
LMO11FG011	13/16	13/16	22	24	38	28	420	6091
LMO13FG013	1	1	27	30	41	33.5	420	6091
LMO14FG014	1.3/16	1.3/16	30	36	46.5	37.5	420	6091
LMO15FG015	1.7/16	1.7/16	36	41	53.5	41.5	380	5511
LMO21FG021	1.11/16	1.11/16	41	50	58	44.5	280	4060
LMO32FG032	2	2	48	60	61	49	280	4060

45° ADAPTOR FEMALE ORFS – MALE ORFS

GOMITO A 45° FEMMINA ORFS DADO PRESSATO MASCHIO ORFS
 ADAPTATEUR COUDE 45° FEMELLE ORFS – MÂLE ORFS
 ADAPTER 45° IG-ORFS / AG -ORFS
 CODO 45° HEMBRA ORFS – MACHO ORFS

F1 ORFS

F2 ORFS

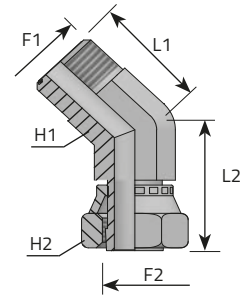

Code	Thread		Dimensions				Pressure	
	F1	F2	H1	H2	L1	L2	Bar	Psi
	in	in	mm	mm	mm	mm		
QM006FG006	9/16	9/16	14	17	16	26.5	630	9136
QM009FG009	11/16	11/16	19	22	19	29	630	9136
QM011FG011	13/16	13/16	22	24	20.5	38	630	9136
QM013FG013	1	1	27	30	23.5	41	420	6091
QM014FG014	1.3/16	1.3/16	30	36	26	46.5	420	6091
QM015FG015	1.7/16	1.7/16	36	41	30	53.5	420	6091
QM021FG021	1.11/16	1.11/16	41	50	32	58	280	4060
QM032FG032	2	2	48	60	37	61	280	4060

RUN FEMALE ORFS-TEE MALE ORFS -TEE MALE ORFS

RACCORDO A "T" MASCHIO ORFS FEMMINA ORFS AL BRACCIO
 ADAPTATEUR TÉ RENVERSÉ MÂLE ORFS - FEMELLE ORFS
 ADAPTER T-STÜCK 2 X AG-ORFS / 1 X IG-ORFS
 ADAPTADOR EN L MACHO ORFS – MACHO ORFS

F1 ORFS

F2 ORFS

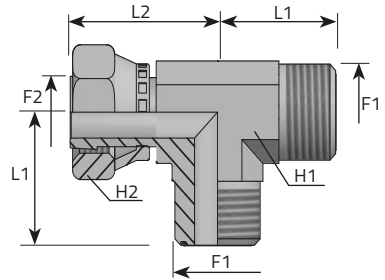

Code	Thread		Dimensions				Pressure	
	F1	F2	H1	H2	L1	L2	Bar	Psi
	in	in	mm	mm	mm	mm		
TMO06FGO06B	9/16	9/16	14	17	21.5	26.5	630	9136
TMO09FGO09B	11/16	11/16	19	22	25	29	630	9136
TMO11FGO11B	13/16	13/16	22	24	28	38	630	9136
TMO13FGO13B	1	1	27	30	33.5	41	420	6091
TMO14FGO14B	1.3/16	1.3/16	30	36	37.5	46.5	420	6091
TMO15FGO15B	1.7/16	1.7/16	36	41	41.5	53.5	420	6091
TMO21FGO21B	1.11/16	1.11/16	41	50	44.5	58	280	4060
TMO32FGO32B	2	2	48	60	49	61	280	4060

BRANCH TEE MALE ORFS - TEE MALE ORFS-FEMALE ORFS

RACCORDO A "T" MASCHIO ORFS FEMMINA ORFS AL PIEDE
 ADAPTATEUR TÉ RENVERSÉ MÂLE ORFS - FEMELLE ORFS
 ADAPTER T-STÜCK 2 X AG-ORFS / 1 X IG-ORFS
 ADAPTADOR EN T MACHO ORFS - MACHO ORFS

F1 ORFS

F2 ORFS

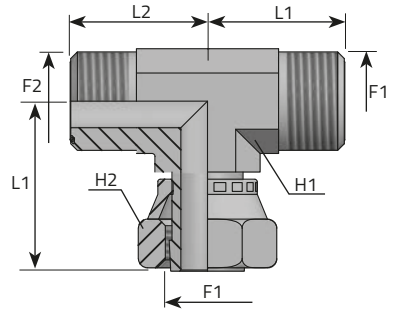

Code	Thread		Dimensions				Pressure	
	F1 in	F2 in	H1 mm	H2 mm	L1 mm	L2 mm	Bar	Psi
TM006FGO06P	9/16	9/16	14	17	21.5	26.5	630	9136
TM009FGO09P	11/16	11/16	19	22	25	29	630	9136
TM011FGO11P	13/16	13/16	22	24	28	38	630	9136
TM013FGO13P	1	1	27	30	33.5	41	420	6091
TM014FGO14P	1.3/16	1.3/16	30	36	37.5	46.5	420	6091
TM015FGO15P	1.7/16	1.7/16	36	41	41.5	53.5	420	6091
TM021FGO21P	1.11/16	1.11/16	41	50	44.5	58	280	4060
TM032FGO32P	2	2	48	60	49	61	280	4060

ADAPTOR FEMALE ORFS - FEMALE ORFS

ADATTATORE DIRITTO FEMMINA ORFS - FEMMINA ORFS DADO PRESSATO
 ADAPTATEUR FEMELLE ORFS - FEMELLE ORFS
 ADAPTER IG-ORFS/IG-ORFS
 ADAPTADOR HEMBRA ORFS - HEMBRA ORFS

F1 ORFS

F2 ORFS

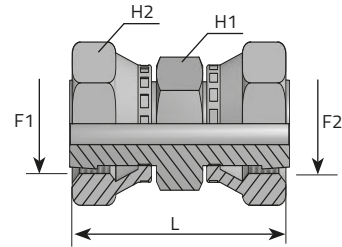

Code	Thread		Dimensions			Pressure	
	F1	F2	H1	H2	L	Bar	Psi
	in	in	mm	mm	mm		
AFGO06	9/16	9/16	17	17	39.5	630	9136
AFGO09	11/16	11/16	19	22	45	630	9136
AFGO11	13/16	13/16	22	24	51.5	630	9136
AFGO13	1	1	27	30	61.5	420	6091
AFGO14	1.3/16	1.3/16	32	36	68	420	6091
AFGO15	1.7/16	1.7/16	41	41	71.5	420	6091
AFGO21	1.11/16	1.11/16	46	50	73.5	280	4060
AFGO32	2	2	55	60	75	280	4060

ADAPTOR MALE ORFS - MALE BSPP FORM E (1)

ADATTATORE DIRITTO MASCHIO ORFS MASCHIO GAS CILINDRICO FORMA E
 ADAPTATEUR MÂLE ORFS - MÂLE BSPP FORME E
 ADAPTER AG-ORFS /AG ZÖLLIG FORM E
 ADAPTADOR MACHO ORFS - MACHO BSPP FORMA E

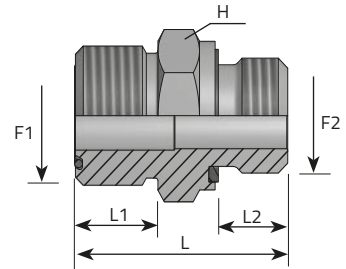

F1 ORFS

F2 Zylinder-Gasgewinde, Gas cilindrico, BSPP, Gaz cylindrique,
 Gas cilíndrica

Code	Thread		Dimensions				Pressure	
	F1 in	F2 in	H mm	L1 mm	L2 mm	L mm	Bar	Psi
AM006MG02R	9/16"	1/8"	17	10	8	25.5	630	9136
AM009MG04R	11/16"	1/4"	19	11	12	32	630	9136
AM011MG06R	13/16"	3/8"	22	13	12	34.5	630	9136
AM013MG08R	1"	1/2"	27	15.5	14	41	420	6091
AM014MG12R	1.3/16"	3/4"	32	17	16	46	420	6091
AM015MG16R	1.7/16"	1"	41	17.5	18	50	420	6091
AM021MG20R	1.11/16"	1.1/4"	50	17.5	20	54	280	4060
AM032MG24R	2"	1.1/2"	55	17.5	22	57.5	280	4060
AM006MG04R	9/16"	1/4"	19	10	12	31	630	9136
AM006MG06R	9/16"	3/8"	22	10	12	31.5	630	9136
AM006MG08R	9/16"	1/2"	27	10	14	35.5	630	9136
AM009MG02R	11/16"	1/8"	19	11	8	27.5	630	9136
AM009MG06R	11/16"	3/8"	22	11	12	32.5	630	9136
AM009MG08R	11/16"	1/2"	27	11	14	36.5	630	9136
AM009MG12R	11/16"	3/4"	32	11	16	40	420	6091
AM011MG04R	13/16"	1/4"	22	13	12	41	630	9136
AM011MG08R	13/16"	1/2"	27	13	14	44	630	9136
AM011MG12R	13/16"	3/4"	32	13	16	46	420	6091

ADAPTOR MALE ORFS - MALE BSPP FORM E (2)

ADATTATORE DIRITTO MASCHIO ORFS MASCHIO GAS CILINDRICO FORMA E
 ADAPTATEUR MÂLE ORFS - MÂLE BSPP FORME E
 ADAPTER AG-ORFS /AG ZÖLLIG FORM E
 ADAPTADOR MACHO ORFS - MACHO BSPP FORMA E

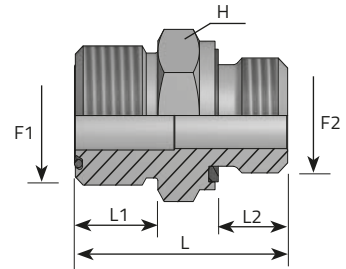

F1 ORFS

F2 Zylinder-Gasgewinde, Gas cilindrico, BSPP, Gaz cylindrique,
 Gas cilíndrica

Code	Thread		Dimensions				Pressure	
	F1	F2	H	L1	L2	L	Bar	Psi
	in	in	mm	mm	mm	mm		
AM013MG04R	1	1/4	27	15.5	12	38	420	6091
AM013MG06R	1	3/8	27	15.5	12	38.5	420	6091
AM013MG12R	1	3/4	32	15.5	16	44.5	420	6091
AM013MG16R	1	1	41	15.5	18	48	420	6091
AM014MG04R	1.3/16	1/4	32	17	12	41	420	6091
AM014MG08R	1.3/16	1/2	32	17	14	44	420	6091
AM014MG16R	1.3/16	1	41	17	18	49.5	420	6091
AM014MG20R	1.3/16	1.1/4	50	17	20	53.5	420	6091
AM015MG04R	1.7/16	1/4	41	17.5	12	43	420	6091
AM015MG06R	1.7/16	3/8	41	17.5	12	43.5	420	6091
AM015MG12R	1.7/16	3/4	41	17.5	16	48	420	6091
AM015MG20R	1.7/16	1.1/4	50	17.5	20	54	420	6091
AM015MG24R	1.7/16	1.1/2	55	17.5	22	57.5	280	4060
AM021MG16R	1.11/16	1	46	17.5	18	52	280	4060
AM021MG24R	1.11/16	1.1/2	55	17.5	22	57.5	280	4060

ADAPTOR MALE ORFS - MALE BSPP WITH 60° CONE

ADATTATORE DIRITTO MASCHIO ORFS MASCHIO BSPP SVASATO 60°
 ADAPTATEUR MÂLE ORFS - MÂLE BSPP AVEC CÔNE 60°
 ADAPTER AG-ORFS/AG-BSPP MIT 60° KONUS
 ADAPTADOR MACHO ORFS -MACHO BSPP CON CONO 60°

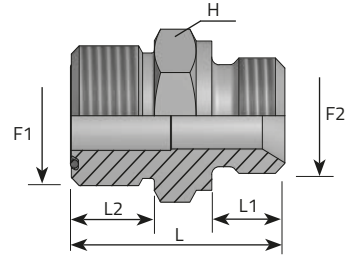

F1 ORFS

F2 Zylinder-Gasgewinde, Gas cilindrico, BSPP, Gaz cylindrique,
 Gas cilíndrica

Code	Thread		Dimensions				Pressure	
	F1	F2	H	L1	L2	L	Bar	Psi
	in	in	mm	mm	mm	mm		
AM006MG02SV	9/16	1/8	17	8	10	25.5	400	5801
AM009MG04SV	11/16	1/4	19	11	11	32	400	5801
AM011MG06SV	13/16	3/8	22	12	13	34.5	400	5801
AM013MG08SV	1	1/2	27	14	15.5	41	350	5076
AM014MG12SV	1.3/16	3/4	32	16	17	46	315	4568
AM015MG16SV	1.7/16	1	41	19	17.5	51	250	3625
AM021MG20SV	1.11/16	1.1/4	50	20	17.5	54	200	2900
AM032MG24SV	2	1.1/2	55	23	17.5	57.5	160	2320
AM006MG04SV	9/16	1/4	19	11	10	31	400	5801
AM006MG06SV	9/16	3/8	22	12	10	31.5	400	5801
AM009MG06SV	11/16	3/8	22	12	11	32.5	400	5801
AM009MG08SV	11/16	1/2	27	14	11	36.5	350	5076
AM011MG04SV	13/16	1/4	22	11	13	35	400	5801
AM011MG08SV	13/16	1/2	27	14	13	38.5	350	5076
AM011MG12SV	13/16	3/4	32	16	13	42	315	4568
AM013MG06SV	1	3/8	27	12	15.5	38.5	400	5801
AM013MG10SV	1	5/8	30	16	15.5	43	350	5076
AM013MG12SV	1	3/4	32	16	15.5	44.5	315	4568
AM014MG08SV	1.3/16	1/2	32	14	17	44	350	5076
AM014MG16SV	1.3/16	1	41	19	17	50.5	250	3625
AM015MG12SV	1.7/16	3/4	41	16	17.5	51	315	4568
AM015MG20SV	1.7/16	1.1/4	50	20	17.5	54	200	2900

ADAPTOR MALE ORFS - FIXED FEMALE BSPP

ADATTATORE DIRITTO MASCHIO ORFS FEMMINA FISSA BSPP
 ADAPTATEUR MÂLE ORFS - FEMELLE FIXE BSPP
 ADAPTER AG-ORFS/IG-ZÖLLIG
 ADAPTADOR MACHO ORFS -HEMBRA FIJA BSPP

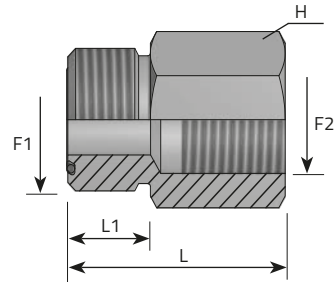

F1 ORFS

F2 Zylinder-Gasgewinde, Gas cilindrico, BSPP, Gaz cylindrique, Gas cilíndrica

Code	Thread		Dimensions			Pressure	
	F1	F2	H	L1	L	Bar	Psi
	in	in	mm	mm	mm		
AM006FFG04	9/16	1/4	19	10	31	630	9136
AM009FFG04	11/16	1/4	19	11	32	630	9136
AM011FFG06	13/16	3/8	24	13	35	630	9136
AM013FFG08	1	1/2	30	15.5	41,5	420	6091
AM014FFG12	1.3/16	3/4	36	17	46	420	6091
AM015FFG16	1.7/16	1	41	17.5	48,5	420	6091
AM021FFG20	1.11/16	1.1/4	55	17.5	53,5	280	4060
AM032FFG24	2	1.1/2	60	17.5	55,5	280	4060
AM011FFG04	13/16	1/4	22	13	34	630	9136
AM014FFG08	1.3/16	1/2	32	17	43	420	6091

STRAIGHT BULKHEAD ADAPTOR MALE ORFS - FEMALE BSPP

ADATTATORE PASSAPARETE MASCHIO ORFS FEMMINA BSPP
 PASSE-CLOISON MÂLE ORFS- FEMELLE BSPP
 SCHOTTADAPTER AG-ORFS / IG- BSPP
 PASATABIQUE MACHO ORFS - HEMBRA BSPP

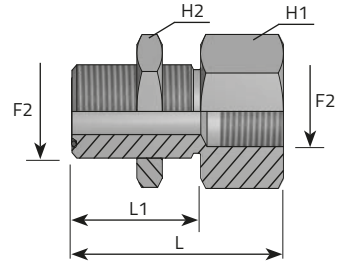

F1 ORFS

F2 Zylinder-Gasgewinde, Gas cilindrico, BSPP, Gaz cylindrique, Gas cilindrica

Code	Thread		Dimensions				Pressure	
	F1	F2	H1	H2	L1	L	Bar	Psi
	in	in	mm	mm	mm	mm		
APPM006FFG04	9/16	1/4	22	22	31.5	52.5	630	9136
APPM009FFG04	11/16	1/4	27	27	34	55	630	9136
APPM011FFG06	13/16	3/8	30	30	36.5	58.5	630	9136
APPM013FFG08	1	1/2	36	36	40.5	66.5	420	6091
APPM014FFG12	1.3/16	3/4	41	41	41.5	70.5	420	6091
APPM015FFG16	1.7/16	1	46	46	42	73	420	6091
APPM021FFG20	1.11/16	1.1/4	50	50	42	78	280	4060
APPM032FFG24	2	1.1/2	60	60	42	80	280	4060

ORFS SWIVEL NUT - BSPP FEMALE

PRESA DI PRESSIONE CON DADO GIREVOLE ORFS FEMMINA BSPP
 ÉCROU TOURNANTE ORFS - FEMELLE BSPP -
 ORFS GIRATORIA MÜTTER - AG BSPP
 TUERCA ORFS -HEMBRA BSPP

F1 ORFS

F2 Zylinder-Gasgewinde, Gas cilindrico, BSPP, Gaz cylindrique,
 Gas cilíndrica

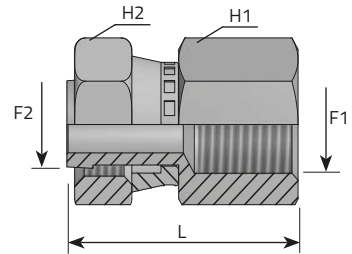

Code	Thread		Dimensions			Pressure	
	F1	F2	H1	H2	L	Bar	Psi
	in	in	mm	mm	mm		
AFGO06FFG04	9/16	1/4	19	17	39	630	9136
AFGO09FFG04	11/16	1/4	19	22	41	630	9136
AFGO11FFG04	13/16	1/4	19	24	43	630	9136
AFGO13FFG04	1	1/4	24	30	46	420	6091
AFGO14FFG04	1.3/16	1/4	30	36	47.5	420	6091
AFGO15FFG04	1.7/16	1/4	36	41	48	420	6091
AFGO21FFG04	1.11/16	1/4	-	50	-	280	4060
AFGO32FFG04	2	1/4	-	60	-	280	4060

ADAPTOR FEMALE ORFS - MALE BSPP WITH 60° CONE

ADATTATORE DIRITTO FEMMINA ORFS MASCHIO BSPP SVASATO 60°
 ADAPTATEUR FEMELLE ORFS - MÂLE BSPP AVEC CÔNE 60°
 ADAPTER IG-ORFS/AG-BSPP MIT 60° KONUS
 ADAPTADOR HEMBRA ORFS - MACHO BSPP CON CONO 60°

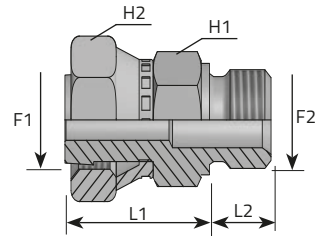

F1 ORFS

F2 Zylinder-Gasgewinde, Gas cilindrico, BSPP, Gaz cylindrique,
Gas cilíndrica

Code	Thread		Dimensions				Pressure	
	F1	F2	H1	H2	L1	L2	Bar	Psi
	in	in	mm	mm	mm	mm		
AFGO06MG02SV	9/16	1/8	14	17	25,00	8	400	5801
AFGO09MG04SV	11/16	1/4	19	22	29,00	12	400	5801
AFGO11MG06SV	13/16	3/8	22	24	35,50	12	400	5801
AFGO13MG08SV	1	1/2	27	30	39,50	14	350	5076
AFGO14MG12SV	1.3/16	3/4	32	36	41,50	16	315	4568
AFGO15MG16SV	1.7/16	1	41	41	46,00	18	250	3625
AFGO21MG20SV	1.11/16	1.1/4	50	50	44,50	20	200	2900
AFGO32MG24SV	2	1.1/2	55	60	49,50	22	160	2320
AFGO06MG04SV	9/16	1/4	19	17	25,50	12	400	5801
AFGO06MG06SV	9/16	3/8	22	17	27,50	12	400	5801
AFGO09MG06SV	11/16	3/8	22	22	29,50	12	400	5801
AFGO09MG08SV	11/16	1/2	27	22	30,50	14	350	5076
AFGO11MG04SV	13/16	1/4	19	24	33,50	11	400	5801
AFGO11MG08SV	13/16	1/2	27	24	37,00	14	350	5076
AFGO11MG12SV	13/16	3/4	32	24	40,50	16	315	4568
AFGO13MG06SV	1	3/8	24	30	39,00	12	400	5801
AFGO13MG10SV	1	5/8	30	30	39,00	16	350	5076
AFGO13MG12SV	1	3/4	32	30	41,00	16	315	4568
AFGO14MG08SV	1.3/16	1/2	30	36	43,50	14	350	5076
AFGO14MG16SV	1.3/16	1	41	36	44,00	19	250	3625
AFGO15MG12SV	1.7/16	3/4	36	41	46,00	16	315	4568
AFGO15MG20SV	1.7/16	1.1/4	50	41	47,50	20	200	2900

ADAPTOR FEMALE ORFS - MALE BSPP FORM E

ADATTATORE DIRITTO FEMMINA ORFS MASCHIO BSPP FORMA E
 ADAPTATEUR FEMELLE ORFS - MÂLE BSPP FORME E
 ADAPTER IG-ORFS/AG-BSPP FORM E
 ADAPTADOR HEMBRA ORFS - MACHO BSPP FORMA E

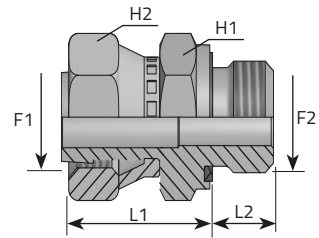

F1 ORFS

F2 Zylinder-Gasgewinde, Gas cilindrico, BSPP, Gaz cylindrique,
 Gas cilindra

Code	Thread		Dimensions				Pressure	
	F1	F2	H1	H2	L1	L2	Bar	Psi
	in	in	mm	mm	mm	mm		
AFG006MG02R	9/16	1/8	17	17	26.5	8	630	9136
AFG009MG04R	11/16	1/4	19	22	28.5	12	630	9136
AFG011MG06R	13/16	3/8	22	24	35.5	12	630	9136
AFG013MG08R	1	1/2	27	30	38	14	420	6091
AFG014MG12R	1.3/16	3/4	32	36	41.5	16	420	6091
AFG015MG16R	1.7/16	1	41	41	49	18	420	6091
AFG021MG20R	1.11/16	1.1/4	50	50	49	20	280	4060
AFG032MG24R	2	1.1/2	55	60	49	22	280	4060
AFG006MG04R	9/16	1/4	19	17	26.5	12	630	9136
AFG009MG06R	11/16	3/8	22	22	32.5	12	630	9136
AFG011MG08R	13/16	1/2	27	24	34	14	630	9136
AFG014MG20R	1.3/16	1.1/4	50	36	48	20	420	6091

ADAPTOR MALE ORFS - METRIC MALE FORM E (1)

ADATTATORE DIRITTO MASCHIO ORFS MASCHIO METRICO FORMA E
 ADAPTATEUR MÂLE ORFS - MÂLE MÉTRIQUE FORME E
 ADAPTER AG-ORFS/AG-METRISCHFORM E
 ADAPTADOR MACHO ORFS -MACHO MÉTRICOFORMA E

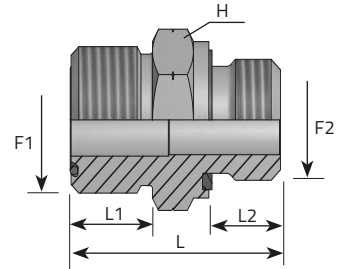

F1 ORFS

F2 Metrisch, Metrico, Metric, Métrique, Métrico

Code	Thread		Dimensions				Pressure	
	F1 in	F2 mm	H mm	L1 mm	L2 mm	L mm	Bar	Psi
AM006MM12R	9/16	12X1.5	17	10	12	30	630	9136
AM009MM14R	11/16	14X1.5	19	11	12	32	630	9136
AM011MM18R	13/16	18X1.5	24	13	12	34,5	630	9136
AM013MM22R	1	22X1.5	27	15.5	14	41	420	6091
AM014MM27R	1.3/16	27X2	32	17	16	46	420	6091
AM015MM33R	1.7/16	33X2	41	17.5	18	50	420	6091
AM021MM42R	1.11/16	42X2	50	17.5	20	54	280	4060
AM032MM48R	2	48X1.5	55	17.5	22	57,5	280	4060
AM006MM10R	9/16	10X1	17	10	8	25,5	350	5076
AM006MM14R	9/16	14X1.5	19	10	12	31	630	9136
AM009MM12R	11/16	12X1.5	19	11	12	32	630	9136
AM009MM16R	11/16	16X1.5	22	11	12	34	630	9136
AM009MM18R	11/16	18X1.5	24	11	12	32,5	630	9136
AM011MM14R	13/16	14X1.5	22	13	12	35	630	9136
AM011MM16R	13/16	16X1.5	22	13	12	34,5	630	9136
AM011MM22R	13/16	22X1.5	27	13	14	38,5	630	9136

ADAPTOR MALE ORFS - METRIC MALE FORM E (2)

ADATTATORE DIRITTO MASCHIO ORFS MASCHIO METRICO FORMA E
 ADAPTATEUR MÂLE ORFS - MÂLE MÉTRIQUE FORME E
 ADAPTER AG-ORFS/AG-METRISCHFORM E
 ADAPTADOR MACHO ORFS -MACHO MÉTRICOFORMA E

F1 ORFS

F2 Metrisch, Metrico, Metric, Métrique, Métrico

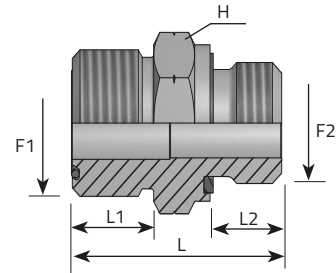

Code	Thread		Dimensions				Pressure	
	F1	F2	H	L1	L2	L	Bar	Psi
	in	mm	mm	mm	mm	mm		
AM013MM18R	1	18x1.5	27	15.5	12	38,5	420	6091
AM013MM27R	1	27x2	32	15.5	16	44,5	420	6091
AM014MM22R	1.3/16	22x1.5	32	17	14	44	420	6091
AM014MM33R	1.3/16	33x2	41	17	18	49,5	420	6091
AM015MM27R	1.7/16	27x2	41	17.5	16	48	420	6091
AM015MM42R	1.7/16	42x2	50	17.5	20	54	420	6091
AM021MM33R	1.11/16	33x2	46	17.5	18	52	280	4060
AM021MM48R	1.11/16	48x2	55	17.5	22	57,5	280	4060

ADAPTOR MALE ORFS - METRIC MALE

ADATTATORE DIRITTO MASCHIO ORFS MASCHIO METRICO CON O-RING
 ADAPTATEUR MÂLE ORFS - MÂLE MÉTRIQUE AVEC O-RING
 ADAPTER AG-ORFS/AG-METRISCH MIT O.R.
 ADAPTADOR MACHO ORFS -MACHO MÉTRICO

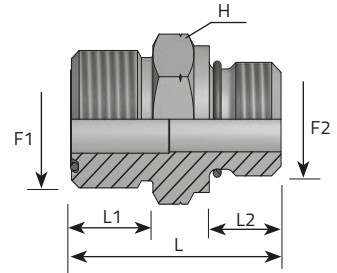

F1 ORFS

F2 Metrisch, Metrico, Metric, Métrique, Métrico

Code	Thread		Dimensions				Pressure	
	F1 in	F2 mm	H mm	L1 mm	L2 mm	L mm	Bar	Psi
AM009MM14	11/16	14x1.5	19	11	13.5	35	630	9136
AM009MM12	11/16	12X1.5	22	13	13.5	32	630	9136
AM011MM22	13/16	22X1.5	22	13	17	38.5	630	9136
AM014MM22	1.3/16	22X1.5	32	17	17	44	630	9136
AM015MM27	1.7/16	27X2	41	17.5	19	48	420	6091
AM015MM33	1.7/16	33X2	41	17.5	22	50	420	6091
AM021MM42	1.11/16	42X2	50	17.5	22	50	280	6091

ORFS SWIVEL NUT - METRIC FEMALE

PRESA DI PRESSIONE CON DADO GIREVOLE ORFS FEMMINA METRICA
 ÉCROU TOURNANTE ORFS - FEMELLE MÉTRIQUE
 ORFS MÜTTER - AG METRISCH
 TUERCA GIRATORIA ORFS - HEMBRA MÉTRICA

F1 ORFS

F2 Metrisch, Metrico, Metric, Métrique, Métrico

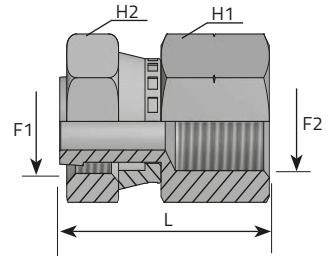

Code	Thread		Dimensions			Pressure	
	F1	F2	H1	H2	L	Bar	Psi
	in	mm	mm	mm	mm		
AFGO06FFM10	9/16	10x1	19	17	39	630	9136
AFGO09FFM10	11/16	10x1	19	22	41	630	9136
AFGO11FFM10	13/16	10x1	19	24	43	630	9136
AFGO13FFM10	1	10x1	24	30	40	420	6091
AFGO14FFM10	1.3/16	10x1	-	36	-	420	6091
AFGO15FFM10	1.7/16	10x1	-	41	-	420	6091
AFGO21FFM10	1.11/16	10x1	-	50	-	280	4060
AFGO32FFM10	2	10x1	-	60	-	280	4060

ADAPTOR FEMALE ORFS - MALE METRIC FORM E

ADATTATORE DIRITTO FEMMINA ORFS MASCHIO METRICO FORMA E
 ADAPTATEUR FEMELLE ORFS - MÂLE MÉTRIQUE FORME E
 ADAPTER IG-ORFS/AG-METRISCH FORM E
 ADAPTADOR HEMBRA ORFS - MACHO MÉTRICO FORMA E

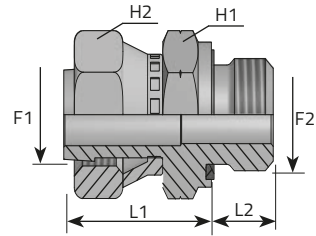

F1 ORFS

F2 Metrisch, Metrico, Metric, Métrique, Métrico

Code	Thread		Dimensions				Pressure	
	F1 in	F2 mm	H1 mm	H2 mm	L1 mm	L2 mm	Bar	Psi
AFGO06MM12R	9/16	12X1.5	17	17	26.5	12	630	9136
AFGO09MM14R	11/16	14X1.5	19	22	28.5	12	630	9136
AFGO11MM18R	13/16	18X1.5	24	24	35.5	12	630	9136
AFGO13MM22R	1	22X1.5	27	30	38	14	420	6091
AFGO14MM27R	1.3/16	27X2	32	36	41.5	16	420	6091
AFGO15MM33R	1.7/16	33X2	41	41	49	18	420	6091
AFGO21MM42R	1.11/16	42X2	50	50	49	20	280	4060
AFGO32MM48R	2	48X2	55	60	49	22	280	4060
AFGO06MM10R	9/16	10X1	17	17	26.5	8	350	5076
AFGO09MM16R	11/16	16X1.5	22	22	28.5	12	630	9136
AFGO11MM16R	13/16	16X1.5	22	24	34.5	12	630	9136
AFGO13MM18R	1	18X1.5	27	30	38	12	420	6091
AFGO14MM22R	1.3/16	22X1.5	32	36	41.5	14	420	6091
AFGO15MM27R	1.7/16	27X2	41	41	49	16	420	6091

ADAPTOR MALE ORFS - MALE UNF (1)

ADATTATORE DIRITTO MASCHIO ORFS MASCHIO UNF
 ADAPTATEUR MÂLE ORFS - MÂLE UNF
 ADAPTER AG-ORFS/AG-UNF
 ADAPTADOR MACHO ORFS - MACHO UNF

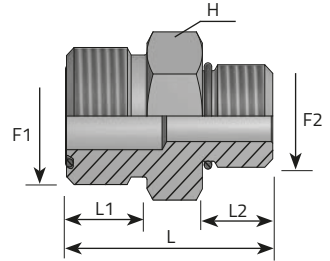

F1 ORFS

F2 UNF

Code	Thread		Dimensions				Pressure	
	F1	F2	H	L1	L2	L	Bar	Psi
	in	in	mm	mm	mm	mm		
AM006MU04	9/16	7/16	17	10	11	29	630	9136
AM009MU06	11/16	9/16	19	11	12	32	630	9136
AM011MU08	13/16	3/4	22	13	14	36,5	630	9136
AM013MU10	1	7/8	27	15,5	16	43	420	6091
AM014MU12	1.3/16	1.1/16	32	17	18,5	48,5	420	6091
AM015MU16	1.7/16	1.5/16	41	17,5	18,5	50,5	420	6091
AM021MU20	1.11/16	1.5/8	46	17,5	18,5	52	280	4060
AM032MU24	2	1.7/8	55	17,5	18,5	54	280	4060
AM006MU05	9/16	1/2	17	10	11	29	630	9136
AM006MU06	9/16	9/16	19	10	12	31	630	9136
AM006MU08	9/16	3/4	22	10	14	33,5	630	9136
AM009MU04	11/16	7/16	19	11	11	31	630	9136
AM009MU05	11/16	1/2	19	11	11	31	630	9136
AM009MU08	11/16	3/4	22	11	14	34,5	630	9136
AM009MU10	11/16	7/8	27	11	16	38,5	630	9136
AM009MU12	11/16	1.1/16	32	11	18,5	42,5	420	6091

ADAPTOR MALE ORFS - MALE UNF (2)

ADATTATORE DIRITTO MASCHIO ORFS MASCHIO UNF
 ADAPTATEUR MÂLE ORFS - MÂLE UNF
 ADAPTER AG-ORFS/AG-UNF
 ADAPTADOR MACHO ORFS - MACHO UNF

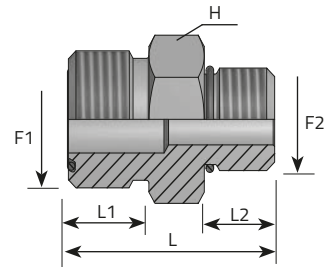

F1 ORFS

F2 UNF

Code	Thread		Dimensions				Pressure	
	F1	F2	H	L1	L2	L	Bar	Psi
	in	in	mm	mm	mm	mm		
AMO11MU06	13/16	9/16	22	13	12	34,5	630	9136
AMO11MU10	13/16	7/8	27	13	16	40,5	630	9136
AMO11MU12	13/16	1.1/16	32	13	18.5	44,5	420	6091
AMO11MU16	13/16	1.5/16	41	13	18.5	46	420	6091
AMO13MU08	1	3/4	27	15.5	14	41	420	6091
AMO13MU12	1	1.1/16	32	15.5	18.5	47	420	6091
AMO14MU08	1.3/16	3/4	32	17	14	44	420	6091
AMO14MU10	1.3/16	7/8	32	17	16	46	420	6091
AMO14MU16	1.3/16	1.5/16	41	17	18.5	50	420	6091
AMO15MU12	1.7/16	1.1/16	41	17.5	18.5	50,5	420	6091
AMO15MU20	1.7/16	1.5/8	46	17.5	15	48.5	280	4060
AMO21MU16	1.11/16	1.5/16	46	17.5	18.5	52	280	4060
AMO21MU24	1.11/16	1.7/8	55	17.5	18.5	54	280	4060
AMO32MU20	2	1.5/8	55	17.5	15	50.5	280	4060

ADAPTOR FEMALE ORFS - MALE UNF

ADATTATORE DIRITTO FEMMINA ORFS DADO PRESSATO MASCHIO UNF
 ADAPTATEUR FEMELLE ORFS - MÂLE UNF
 ADAPTER IG-ORFS/AG-UNF
 ADAPTADOR HEMBRA ORFS - MACHO UNF

F1 ORFS

F2 UNF

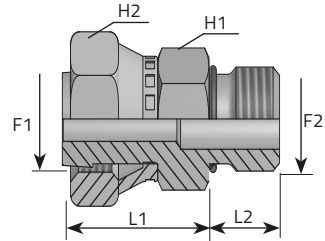

Code	Thread		Dimensions				Pressure	
	F1	F2	H1	H2	L1	L2	Bar	Psi
	in	in	mm	mm	mm	mm		
AFGO06MU04	9/16	7/16	17	17	26.5	11	630	9136
AFGO09MU06	11/16	9/16	19	22	28.5	12	630	9136
AFGO11MU08	13/16	3/4	22	24	35.5	14	630	9136
AFGO13MU10	1	7/8	27	30	38	16	420	6091
AFGO14MU12	1.3/16	1.1/16	32	36	41.5	18.5	420	6091
AFGO15MU16	1.7/16	1.5/16	41	41	49	18.5	420	6091
AFGO21MU20	1.11/16	1.5/8	46	50	49	18.5	280	4060
AFGO32MU24	2	1.7/8	55	60	49	18.5	280	4060
AFGO09MU04	11/16	7/16	19	22	28.5	11	630	9136
AFGO09MU08	11/16	3/4	22	22	32.5	11	630	9136
AFGO11MU10	13/16	7/8	27	24	34	16	630	9136
AFGO13MU08	1	3/4	27	30	38	14	420	6091
AFGO13MU12	1	1.1/16	32	30	39	18.5	420	6091
AFGO14MU10	1.3/16	7/8	32	36	41.5	16	420	6091
AFGO14MU16	1.3/16	1.5/16	41	36	48	18.5	420	6091

ADAPTOR MALE ORFS - MALE NPT

ADATTATORE DIRITTO MASCHIO ORFS MASCHIO NPT

ADAPTATEUR MÂLE ORFS - MÂLE NPT

ADAPTER AG-ORFS/AG-NPT

ADAPTADOR MACHO ORFS - MACHO NPT

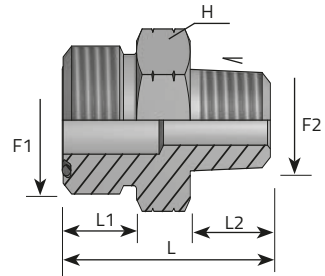

F1 ORFS

F2 NPT

Code	Thread		Dimensions				Pressure	
	F1	F2	H	L1	L2	L	Bar	Psi
	in	in	mm	mm	mm	mm		
AM006MN02	9/16	1/8	17	10	10	27,5	420	6091
AM009MN04	11/16	1/4	19	11	14,5	34,5	630	9136
AM011MN06	13/16	3/8	22	13	14,5	37	630	9136
AM013MN08	1	1/2	27	15,5	19	46	420	6091
AM014MN12	1.3/16	3/4	32	17	19	49	420	6091
AM015MN16	1.7/16	1	41	17,5	24	56	420	6091
AM021MN20	1.11/16	1.1/4	46	17,5	25	59	280	4060
AM032MN24	2	1.1/2	55	17,5	26	61,5	280	4060
AM006MN04	9/16	1/4	17	10	14,5	32	630	9136
AM006MN06	9/16	3/8	17	10	14,5	32	630	9136
AM009MN06	11/16	3/8	19	11	14,5	34,5	630	9136
AM009MN08	11/16	1/2	22	11	19	39,5	630	9136
AM011MN04	13/16	1/4	22	13	14,5	37	630	9136
AM011MN08	13/16	1/2	22	13	19	41,5	630	9136
AM011MN12	13/16	3/4	27	13	19	43,5	420	6091
AM013MN06	1	3/8	27	15,5	14,5	41,5	420	6091
AM013MN12	1	3/4	27	15,5	19	46	420	6091
AM014MN08	1.3/16	1/2	32	17	19	49	420	6091
AM014MN16	1.3/16	1	36	17	24	54	420	6091
AM015MN12	1.7/16	3/4	41	17,5	19	51	420	6091
AM021MN16	1.11/16	1	46	17,5	24	58	280	4060
AM032MN20	2	1.1/4	55	17,5	25	60,5	280	4060

90° ADAPTOR MALE ORFS - MALE NPT

GOMITO 90° MASCHIO ORFS MASCHIO NPT
 ADAPTATEUR COUDE 90° MÂLE ORFS - MÂLE NPT
 ADAPTER 90° GSK AG-ORFS/AG-NPT
 CODO 90° MACHO ORFS - MACHO NPT

F1 ORFS

F2 NPT

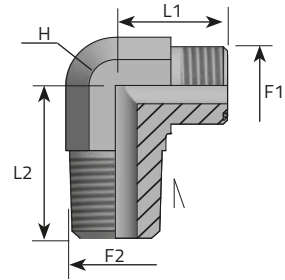

Code	Thread		Dimensions			Pressure	
	F1	F2	H	L1	L2	Bar	Psi
	in	in	mm	mm	mm		
LMO06MN02	9/16	1/8	14	21.5	20	420	6091
LMO09MN04	11/16	1/4	19	25	31	630	9136
LMO11MN06	13/16	3/8	22	28	31	630	9136
LMO13MN08	1	1/2	27	33.5	37.5	420	6091
LMO14MN12	1.3/16	3/4	30	37.5	40	420	6091
LMO15MN16	1.7/16	1	36	41.5	50	420	6091
LMO21MN20	1.11/16	1.1/4	41	52	60	280	4060
LMO32MN24	2	1.1/2	48	49	67	280	4060
LMO06MN04	9/16	1/4	14	21.5	28	630	9136
LMO06MN06	9/16	3/8	19	23.5	31	630	9136
LMO09MN06	11/16	3/8	19	25	31	630	9136
LMO09MN08	11/16	1/2	22	28	37.5	630	9136
LMO11MN04	13/16	1/4	22	28	31	630	9136
LMO11MN08	13/16	1/2	22	30	37.5	630	9136
LMO11MN12	13/16	3/4	27	31.5	40	420	6091
LMO13MN06	1	3/8	27	33.5	33	420	6091
LMO13MN12	1	3/4	27	33.5	40	420	6091
LMO14MN08	1.3/16	1/2	30	37.5	40	420	6091
LMO14MN16	1.3/16	1	33	38	50	420	6091
LMO15MN12	1.7/16	3/4	36	41.5	45.5	420	6091
LMO21MN16	1.11/16	1	41	52	59	280	4060
LMO32MN20	2	1.1/4	48	49	66	280	4060

45° ADAPTOR MALE ORFS - MALE NPT

GOMITO 45° MASCHIO ORFS MASCHIO NPT
 ADAPTATEUR COUDE 45° MÂLE ORFS - MÂLE NPT
 ADAPTER 45° GSK AG-ORFS/AG-NPT
 CODO 45° MACHO ORFS - MACHO NPT

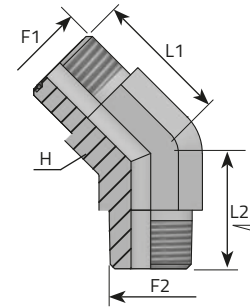

F1 ORFS
 F2 NPT

Code	Thread		Dimensions			Pressure	
	F1	F2	H	L1	L2	Bar	Psi
	in	in	mm	mm	mm		
QMO06MN02	9/16	1/8	14	16	16.5	420	6091
QMO09MN04	11/16	1/4	19	19	24	630	9136
QMO11MN06	13/16	3/8	22	20.5	24	630	9136
QMO13MN08	1	1/2	27	23.5	30.5	420	6091
QMO14MN12	1.3/16	3/4	30	26	30.5	420	6091
QMO15MN16	1.7/16	1	36	30	38	420	6091
QMO21MN20	1.11/16	1.1/4	41	32	42	280	4060
QMO32MN24	2	1.1/2	48	37	45	280	4060
QMO06MN04	9/16	1/4	14	16	22	630	9136
QMO06MN06	9/16	3/8	19	17.5	24	630	9136
QMO09MN06	11/16	3/8	19	19	24	630	9136
QMO09MN08	11/16	1/2	22	20	29.5	630	9136
QMO11MN04	13/16	1/4	22	20.5	24	630	9136
QMO11MN08	13/16	1/2	22	21	29.5	630	9136
QMO11MN12	13/16	3/4	27	21.5	30.5	420	6091
QMO13MN06	1	3/8	27	23.5	27	420	6091
QMO13MN12	1	3/4	27	23.5	30.5	420	6091
QMO14MN08	1.3/16	1/2	30	26	30.5	420	6091
QMO14MN16	1.3/16	1	33	29.5	38	420	6091
QMO15MN12	1.7/16	3/4	36	30	33	420	6091
QMO21MN16	1.11/16	1	41	32	41	280	4060
QMO32MN20	2	1.1/4	48	37	44	280	4060

ADAPTOR MALE ORFS - FIXED FEMALE NPT

ADATTATORE DIRITTO MASCHIO ORFS FEMMINA FISSA NPT
 ADAPTATEUR MÂLE ORFS - FEMELLE FIXE NPT
 ADAPTER AG-ORFS/ IG-NPT
 ADAPTADOR MACHO ORFS -HEMBRA FIJA NPT

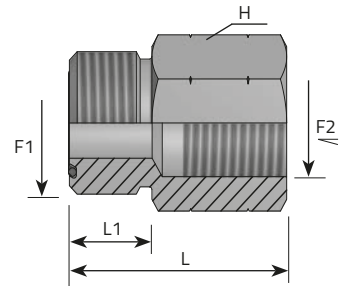

F1 ORFS

F2 NPT

Code	Thread		Dimensions			Pressure	
	F1	F2	H	L1	L	Bar	Psi
	in	in	mm	mm	mm		
AM006FFN04	9/16	1/4	19	10	31,5	630	9136
AM009FFN04	11/16	1/4	19	11	32,5	630	9136
AM011FFN06	13/16	3/8	24	13	36	630	9136
AM013FFN08	1	1/2	30	15.5	44	420	6091
AM014FFN12	1.3/16	3/4	36	17	47	420	6091
AM015FFN16	1.7/16	1	41	17.5	54	420	6091
AM021FFN20	1.11/16	1.1/4	55	17.5	56,5	280	4060
AM032FFN24	2	1.1/2	60	17.5	56,5	280	4060
AM011FFN04	13/16	1/4	22	13	34,5	630	9136
AM014FFN08	1.3/16	1/2	32	17	45,5	420	6091

STRAIGHT BULKHEAD ADAPTOR MALE ORFS - FEMALE NPT

ADATTATORE PASSAPARETE MASCHIO ORFS FEMMINA NPT
 PASSE-CLOISON MÂLE ORFS- FEMELLE NPT
 SCHOTTADAPTER AG-ORFS / IG- NPT
 PASATABIQUE MACHO ORFS - HEMBRA NPT

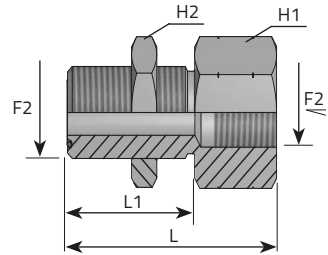

F1 ORFS

F2 NPT

Code	Thread		Dimensions				Pressure	
	F1	F2	H	H1	L1	L	Bar	Psi
	in	in	mm	mm	mm	mm		
APPMO06FFN04	9/16	1/4	22	22	31.5	53	630	9136
APPMO09FFN04	11/16	1/4	27	27	34	55.5	630	9136
APPMO11FFN06	13/16	3/8	30	30	36.5	59	630	9136
APPMO13FFN08	1	1/2	36	36	40.5	69	420	6091
APPMO14FFN12	1.3/16	3/4	41	41	41.5	71.5	420	6091
APPMO15FFN16	1.7/16	1	46	46	42	78.5	420	6091
APPMO21FFN20	1.11/16	1.1/4	50	50	42	81	280	4060
APPMO32FFN24	2	1.1/2	60	60	42	81	280	4060

ADAPTOR MALE ORFS - MALE DIN

ADATTATORE DIRITTO MASCHIO ORFS MASCHIO DIN
 ADAPTATEUR MÂLE ORFS - MÂLE DIN
 ADAPTER AG-ORFS/AG-DIN
 ADAPTADOR MACHO ORFS - MACHO DIN

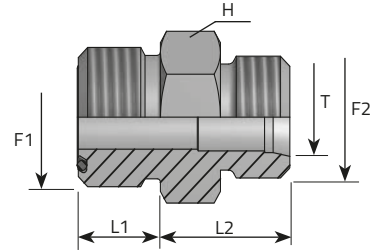

F1 ORFS

F2 DIN

Code	Thread		Dimensions				Pressure	
	F1	F2	H	L1	L2	T	Bar	Psi
	in	in	mm	mm	mm	mm		
AMO06ME06L.1	9/16	12X1.5	17	10	10.5	6	315	4568
AMO06ME08L.1	9/16	14X1.5	17	10	10.5	8	315	4568
AMO09ME10L.1	11/16	16X1.5	19	11	13	10	315	4568
AMO11ME12L.1	13/16	18X1.5	22	13	13.5	12	315	4568
AMO13ME15L.1	1	22X1.5	27	15.5	16.5	15	315	4568
AMO14ME18L.1	1.3/16	26X1.5	32	17	17.5	18	315	4568
AMO15ME22L.1	1.7/16	30X2	41	17.5	21	22	160	2320
AMO21ME28L.1	1.11/16	36X2	46	17.5	23	28	160	2320
AMO32ME35L.1	2	45X2	55	17.5	23.5	35	160	2320
AMO32ME42L.1	2	52X2	55	17.5	23	42	160	2320
AMO06ME06S.1	9/16	14X1.5	17	10	12.5	6	630	9136
AMO06ME08S.1	9/16	16X1.5	17	10	12.5	8	630	9136
AMO09ME10S.1	11/16	18X1.5	19	11	13.5	10	630	9136
AMO11ME12S.1	13/16	20X1.5	22	13	14	12	630	9136
AMO13ME14S.1	1	22X1.5	27	15.5	19.5	14	420	6091
AMO13ME16S.1	1	24X1.5	27	15.5	20	16	400	5801
AMO14ME20S.1	1.3/16	30X2	32	17	18.5	20	400	5801
AMO15ME25S.1	1.7/16	36X2	41	17.5	20.5	25	400	5801
AMO21ME30S.1	1.11/16	42X2	46	17.5	23	30	280	4060
AMO32ME38S.1	2	52X2	55	17.5	24	38	280	4060

ADAPTOR MALE ORFS - FEMALE DIN (THRUST-WIRE NUT)

ADATTATORE DIRITTO MASCHIO ORFS FEMMINA DIN DADO SPINATO
 ADAPTATEUR MÂLE ORFS - FEMELLE DIN (ÉCROU À JONC)
 ADAPTER AG-ORFS/IG-DIN (GESTIFTETE ÜBERWURF MUTTER)
 ADAPTADOR MACHO ORFS - HEMBRA DIN (TUERCA CON SEGURO)

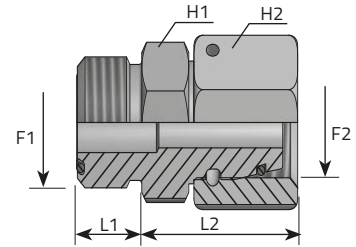

F1 ORFS

F2 DIN

Code	Thread		Dimensions					Pressure	
	F1	F2	H1	H2	L1	L2	T	Bar	Psi
	in	mm	mm	mm	mm	mm	mm		
AMO06FE06L	9/16	12X1.5	17	14	10	24.5	6	315	4568
AMO06FE08L	9/16	14X1.5	17	17	10	24.5	8	315	4568
AMO09FE10L	11/16	16X1.5	19	19	11	26.5	10	315	4568
AMO11FE12L	13/16	18X1.5	22	22	13	27	12	315	4568
AMO13FE15L	1	22X1.5	27	27	15.5	31	15	315	4568
AMO14FE18L	1.3/16	26X1.5	32	32	17	33.5	18	315	4568
AMO15FE22L	1.7/16	30X2	41	36	17.5	36	22	160	2320
AMO21FE28L	1.11/16	36X2	46	41	17.5	39	28	160	2320
AMO32FE35L	2	45X2	55	50	17.5	45	35	160	2320
AMO32FE42L	2	52X2	55	60	17.5	45	42	160	2320
AMO06FE06S	9/16	14X1.5	17	17	10	24.5	6	630	9136
AMO06FE08S	9/16	16X1.5	17	19	10	25	8	630	9136
AMO09FE10S	11/16	18X1.5	19	22	11	27	10	630	9136
AMO11FE12S	13/16	20X1.5	22	24	13	27.5	12	630	9136
AMO13FE14S	1	22X1.5	27	27	15.5	32.5	14	420	6091
AMO13FE16S	1	24X1.5	27	30	15.5	35	16	400	5801
AMO14FE20S	1.3/16	30X2	32	36	17	39	20	400	5801
AMO15FE25S	1.7/16	36X2	41	46	17.5	43	25	400	5801
AMO21FE30S	1.11/16	42X2	46	50	17.5	47.5	30	280	4060
AMO32FE38S	2	52X2	55	60	17.5	51	38	280	4060

ADAPTOR MALE ORFS - MALE JIC

ADATTATORE DIRITTO MASCHIO ORFS MASCHIO JIC (SAE J514)
 ADAPTATEUR MÂLE ORFS - MÂLE JIC
 ADAPTER AG-ORFS/AG-JIC
 ADAPTADOR MACHO ORFS -MACHO JIC

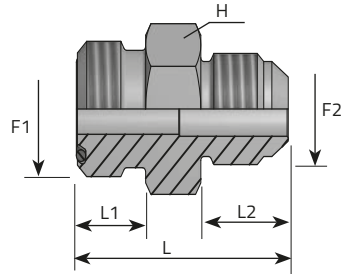

F1 ORFS

F2 JIC

Code	Thread		Dimensions				Pressure	
	F1	F2	H	L1	L2	L	Bar	Psi
	in	in	mm	mm	mm	mm		
AM006MJ04	9/16	7/16	17	10	14	31.5	450	6526
AM009MJ06	11/16	9/16	19	11	14.1	34	350	5076
AM011MJ08	13/16	3/4	22	13	16.7	39	350	5076
AM013MJ10	1	7/8	27	15.5	19.3	46.5	350	5076
AM014MJ12	1.3/16	1.1/16	32	17	21.9	52	350	5076
AM015MJ16	1.7/16	1.5/16	41	17.5	23.1	55	290	4205
AM021MJ20	1.11/16	1.5/8	46	17.5	24.3	58.5	240	3480
AM032MJ24	2	1.7/8	55	17.5	27.5	63	240	3480
AM009MJ05	11/16	1/2	19	11	14	34	450	6526

ADAPTOR MALE ORFS - FEMALE JIC

ADATTATORE DIRITTO MASCHIO ORFS FEMMINA JIC
 ADAPTATEUR MÂLE ORFS - FEMELLE JIC
 ADAPTER AG-ORFS/IG-JIC
 ADAPTADOR MACHO ORFS -HEMBRA JIC

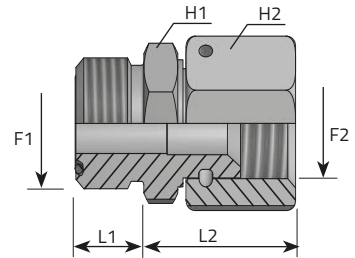

F1 ORFS

F2 JIC

Code	Thread		Dimensions				Pressure		
	F1	F2	H1	H2	L1	L2	form	Bar	Psi
	in	in	mm	mm	mm	mm			
AM006FGJ04	9/16	7/16	17	17	10	25	X	450	6526
AM009FGJ06	11/16	9/16	19	19	11	29	X	350	5076
AM011FGJ08	13/16	3/4	22	22	13	31.5	X	350	5076
AM013FGJ10	1	7/8	27	27	15.5	37.5	X	350	5076
AM014FGJ12	1.3/16	1.1/16	32	32	17	39	Y	350	5076
AM015FGJ16	1.7/16	1.5/16	41	41	17.5	44.5	Y	290	4205
AM021FGJ20	1.11/16	1.5/8	46	50	17.5	45.5	Y	240	3480
AM032FGJ24	2	1.7/8	55	60	17.5	55.5	Y	240	3480
AM009FGJ05	11/16	1/2	19	17	11	28	Y	450	6526

Y: Version with crimped nut

Versione con dado pressato

X: Version with thrust-wire nut

Versione con dado spinato

ADAPTOR FEMALE ORFS - MALE JIC

ADATTATORE DIRITTO FEMMINA ORFS MASCHIO JIC (SAE J514)
 ADAPTATEUR FEMELLE ORFS - MÂLE JIC
 ADAPTER IG-ORFS/AG-JIC
 ADAPTADOR HEMBRA ORFS - MACHO JIC

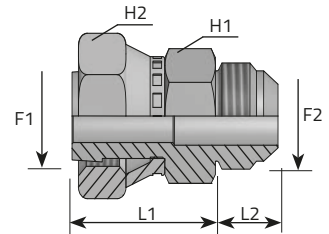

F1 ORFS

F2 JIC

Code	Thread		Dimensions				Pressure	
	F1	F2	H1	H2	L1	L2	Bar	Psi
	in	in	mm	mm	mm	mm		
AFGO06MJ04	9/16	7/16	17	17	23.5	14	450	6526
AFGO09MJ06	11/16	9/16	22	22	26.9	14.1	350	5076
AFGO11MJ08	13/16	3/4	24	24	30.3	16.7	350	5076
AFGO13MJ10	1	7/8	30	30	36.7	19.3	350	5076
AFGO14MJ12	1.3/16	1.1/16	36	36	40.6	21.9	350	5076
AFGO15MJ16	1.7/16	1.5/16	41	41	42.9	23.1	290	4205
AFGO21MJ20	1.11/16	1.5/8	50	50	44.7	24.3	240	3480
AFGO32MJ24	2	1.7/8	60	60	46.5	27.5	240	3480
AFGO09MJ05	11/16	1/2	22	22	27	14	450	6526

WELDING ADAPTOR MALE ORFS (1)

ADATTATORE DIRITTO A SALDARE MASCHIO ORFS CON TASCA
 ADAPTATEUR À SOUDER ORFS
 SCHWEISSVERBINDUNG FÜR HYDRAULIKROHRE MIT VERGROSSERTEM
 LOCHANSATZ- AG-ORFS
 ADAPTADOR MACHO SOLDABLE OR

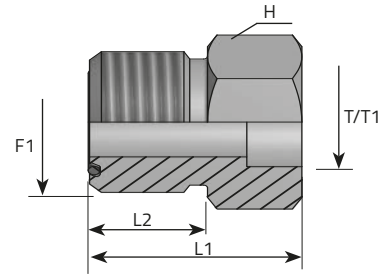

F1 ORFS

T/T1 \emptyset

N.b.: No zinc-plated Parts
 Elementi non sottoposti al trattamento di zincatura

Code	Thread	Dimensions					Pressure	
		F1	H	L1	L2	T	T1	Bar
	in	mm	mm	mm	mm	in		
AMNSO06T6	9/16	17	22	10	6	1/4	630	9136
AMNSO09T10	11/16	19	23	11	10	3/8	630	9136
AMNSO11T12	13/16	22	24.5	13	12	1/2	630	9136
AMNSO13T16	1	27	28	15.5	16	5/8	420	6091
AMNSO14T20	1.3/16	32	33.5	17	20	3/4	420	6091
AMNSO15T25	1.7/16	41	38.5	17.5	25	1	420	6091
AMNSO21T30	1.11/16	46	38.5	17.5	30	1.1/4	280	4060
AMNSO32T38	2	55	38.5	17.5	38	1.1/2	280	4060
AMNSO06T8	9/16	17	22	10	8	5/16	630	9136
AMNSO06T10	9/16	17	22	10	10	3/8	630	9136
AMNSO06T12	9/16	19	22	10	12	1/2	630	9136
AMNSO09T6	11/16	19	23	11	6	1/4	630	9136
AMNSO09T8	11/16	19	23	11	8	5/16	630	9136
AMNSO09T12	11/16	19	23	11	12	1/2	630	9136
AMNSO09T14	11/16	22	23.5	11	14	-	420	6091
AMNSO09T15	11/16	22	23.5	11	15	-	420	6091
AMNSO09T16	11/16	22	23.5	11	16	5/8	420	6091
AMNSO11T6	13/16	22	24.5	13	6	1/4	630	9136
AMNSO11T8	13/16	22	24.5	13	8	5/16	630	9136
AMNSO11T10	13/16	22	24.5	13	10	3/8	630	9136
AMNSO11T14	13/16	22	25	13	14	-	420	6091
AMNSO11T15	13/16	22	25	13	15	-	420	6091

WELDING ADAPTOR MALE ORFS (2)

ADATTATORE DIRITTO A SALDARE MASCHIO ORFS CON TASCA
 ADAPTATEUR À SOUDER ORFS
 SCHWEISSVERBINDUNG FÜR HYDRAULIKROHRE MIT VERGROSSEITEM
 LOCHANSATZ- AG-ORFS
 ADAPTADOR MACHO SOLDABLE OR

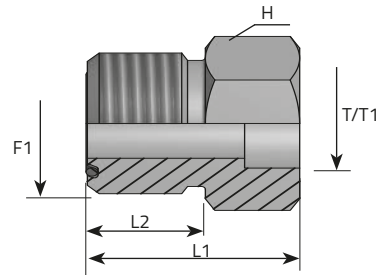

F1 ORFS

T/T1 Ø

N.b.: No zinc-plated Parts

Elementi non sottoposti al trattamento di zincatura

Code	Thread	Dimensions					Pressure	
		H	L1	L2	T	T1	Bar	Psi
	F1							
	in	mm	mm	mm	mm	in	Bar	Psi
AMNSO11T16	13/16	22	25	13	16	5/8	420	6091
AMNSO11T18	13/16	27	28.5	13	18	-	420	6091
AMNSO11T20	13/16	27	28.5	13	20	3/4	420	6091
AMNSO11T22	13/16	32	28.5	13	22	7/8	420	6091
AMNSO11T25	13/16	32	30	13	25	1	420	6091
AMNSO13T10	1	27	27.5	15.5	10	3/8	420	6091
AMNSO13T12	1	27	27.5	15.5	12	1/2	420	6091
AMNSO13T14	1	27	28	15.5	14	-	420	6091
AMNSO13T15	1	27	28	15.5	15	-	420	6091
AMNSO13T18	1	27	31.5	15.5	18	-	420	6091
AMNSO13T20	1	27	31.5	15.5	20	3/4	420	6091
AMNSO14T12	1.3/16	32	29.5	17	12	1/2	420	6091
AMNSO14T14	1.3/16	32	30	17	14	-	420	6091
AMNSO14T15	1.3/16	32	30	17	15	-	420	6091
AMNSO14T16	1.3/16	32	30	17	16	5/8	420	6091
AMNSO14T18	1.3/16	32	33.5	17	18	-	420	6091
AMNSO14T22	1.3/16	32	33.5	17	22	7/8	420	6091
AMNSO14T25	1.3/16	32	35	17	25	1	420	6091
AMNSO15T12	1.7/16	41	33	17.5	12	1/2	420	6091
AMNSO15T14	1.7/16	41	33.5	17.5	14	-	420	6091
AMNSO15T15	1.7/16	41	33.5	17.5	15	-	420	6091
AMNSO15T16	1.7/16	41	33.5	17.5	16	5/8	420	6091

WELDING ADAPTOR MALE ORFS (3)

ADATTATORE DIRITTO A SALDARE MASCHIO ORFS CON TASCA
 ADAPTATEUR À SOUDER ORFS
 SCHWEISSVERBINDUNG FÜR HYDRAULIKROHRE MIT VERGROSSERTEM
 LOCHANSATZ- AG-ORFS
 ADAPTADOR MACHO SOLDABLE OR

F1 ORFS

T/T1 Ø

N.b.: No zinc-plated Parts

Elementi non sottoposti al trattamento di zincatura

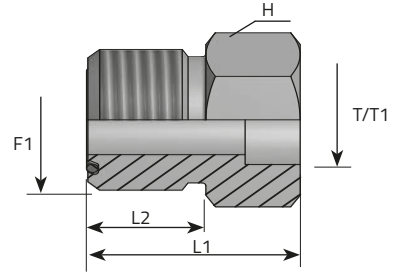

Code	Thread	Dimensions					Pressure	
		F1	H	L1	L2	T	T	Bar
	in	mm	mm	mm	mm	in		
AMNSO15T18	1.7/16	41	37	17.5	18	-	420	6091
AMNSO15T20	1.7/16	41	37	17.5	20	3/4	420	6091
AMNSO15T22	1.7/16	41	37	17.5	22	7/8	420	6091
AMNSO15T28	1.7/16	41	38.5	17.5	28	-	280	4060
AMNSO15T30	1.7/16	41	38.5	17.5	30	1.1/4	280	4060
AMNSO15T32	1.7/16	41	38.5	17.5	32	-	280	4060
AMNSO21T18	1.11/16	46	37	17.5	18	-	280	4060
AMNSO21T20	1.11/16	46	37	17.5	20	3/4	280	4060
AMNSO21T22	1.11/16	46	37	17.5	22	7/8	280	4060
AMNSO21T25	1.11/16	46	38.5	17.5	25	1	280	4060
AMNSO21T28	1.11/16	46	38.5	17.5	28	-	280	4060
AMNSO21T32	1.11/16	46	38.5	17.5	32	-	280	4060
AMNSO21T35	1.11/16	50	38.5	17.5	35	-	280	4060
AMNSO21T38	1.11/16	50	38.5	17.5	38	1.1/2	280	4060
AMNSO32T25	2	55	38.5	17.5	25	1	280	4060
AMNSO32T28	2	55	38.5	17.5	28	-	280	4060
AMNSO32T30	2	55	38.5	17.5	30	1.1/4	280	4060
AMNSO32T32	2	55	38.5	17.5	32	-	280	4060
AMNSO32T35	2	55	38.5	17.5	35	-	280	4060

WELDING ADAPTOR MALE ORFS

CODOLO A SALDARE
EMBOUÏ À SOUDER
SCHWEISSVERBINDUNG FÜR HYDRAULIKROHRE
EMPALME SOLDABLE

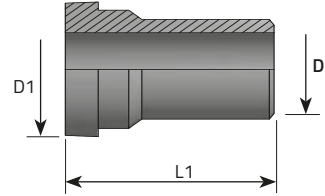

N.b.: No zinc-plated Parts

Elementi non sottoposti al trattamento di zincatura

Code	Thread	Dimensions				Pressure	
		D1	L1	D	D	Bar	Psi
	F1						
	in	mm	mm	in	mm		
T006W		12.75	25	1/4	6	630	9136
T010W		15.75	26	3/8	10	630	9136
T012W		18.9	26	1/2	12	630	9136
T016W		23.45	32	5/8	16	420	6091
T020W		17.85	37	3/4	20	420	6091
T025W		34.2	42	1	25	420	6091
T030W		40.55	44	1.1/4	30	280	4060
T038W		48.5	49	1.1/2	38	280	4060
T008W		15.75	25	5/16	8	630	9136
T014W		23.45	32	-	14	420	6091
T015W		23.45	32	-	15	420	6091
T018W		17.85	37	-	18	420	6091
T022W		34.2	37	7/8	22	420	6091
T028W		40.55	44	-	28	280	4060
T032W		40.55	44	-	32	280	4060
T035W		48.5	44	-	35	280	4060

90° ADAPTOR MALE ORFS - BUTT WELD

GOMITO 90° MASCHIO ORFS ESTREMITÀ A SALDARE
 ADAPTATEUR COUDE 90° À SOUDER MÂLE ORFS
 ADAPTER ANSCHWEISSWINKEL 90° GSK – AG-ORFS
 ADAPTADOR CODO 90° SOLDABLE MACHO ORFS

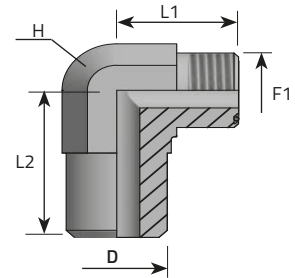

F1 ORFS

N.b.: No zinc-plated Parts
 Elementi non sottoposti al trattamento di zincatura

Code	Thread		Dimensions			Pressure	
	F1	D	H	L1	L2	Bar	Psi
	in	mm	mm	mm	mm		
LM006W6	9/16	6	14	21.5	20	630	9136
LM009W10	11/16	10	19	25	25	630	9136
LM011W12	13/16	12	22	28	25	630	9136
LM013W16	1	16	27	33.5	33.5	420	6091
LM014W20	1.3/16	20	30	37.5	37.5	420	6091
LM015W25	1.7/16	25	36	41.5	42	420	6091
LM021W30	1.11/16	30	41	44.5	45	280	4060
LM032W38	2	38	48	49	61	280	4060
LM009W8	11/16	8	19	25	25	630	9136
LM013W14	1	14	27	33.5	33.5	420	6091
LM013W15	1	15	27	33.5	33.5	420	6091
LM014W18	1.3/16	18	30	37.5	37.5	420	6091
LM015W22	1.7/16	22	36	41.5	42	420	6091
LM021W28	1.11/16	28	41	44.5	45	280	4060
LM021W32	1.11/16	32	41	44.5	45	280	4060
LM032W35	2	35	48	49	61	280	4060

90° ADAPTOR ORFS - SIDE FEMALE TO WELD

GOMITO 90° FEMMINA ORFS ESTREMITÀ A SALDARE
 ADAPTATEUR COUDE 90° À SOUDER FEMÂLE ORFS
 ADAPTER ORFS ANSCHWEISSWINKEL 90° GSK
 ADAPTADOR ORFS CODO 90° HEMBRA SOLDABLE

F1 ORFS

N.b.: No zinc-plated Parts
 Elementi non sottoposti al trattamento di zincatura

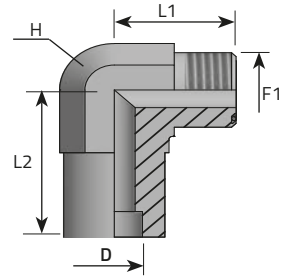

Code	Thread		Dimensions			Pressure	
	F1 in	D mm	H mm	L1 mm	L2 mm	Bar	Psi
LM006T6	9/16	6	14	21.5	20	630	9136
LM009T10	11/16	10	19	25	26	630	9136
LM011T12	13/16	12	22	30	27	630	9136
LM013T16	1	16	27	34	37	420	6091
LM014T20	1.3/16	20	30	37.5	32	420	6091
LM015T25	1.7/16	25	36	41.5	36.5	420	6091
LM021T30	1.11/16	30	41	52	48	280	4060
LM032T38	2	38	48	49	45	280	4060
LM009T8	11/16	8	19	25	25	630	9136
LM013T14	1	14	27	34	32	420	6091
LM013T15	1	15	27	34	32	420	6091
LM014T18	1.3/16	18	30	37.5	32	420	6091
LM015T22	1.7/16	22	36	41.5	37	420	6091
LM021T28	1.11/16	28	41	52	48	280	4060
LM021T32	1.11/16	32	41	52	48	280	4060
LM032T35	2	35	48	49.5	45	280	4060

90° ADJUSTABLE ADAPTOR MALE ORFS – MALE BSPP WITH O-RING (1)

GOMITO 90° MASCHIO ORFS MASCHIO GAS CILINDRICO ORIENTABILE
 ADAPTATEUR ORIENTABLE COUDE 90° MÂLE ORFS- MÂLE BSPP
 ADAPTER 90° GSK – AG-ORFS/ AGR-F MIT O.R. UND HALTER
 CODO 90° ORIENTABLE MACHO ORFS – MACHO BSPP

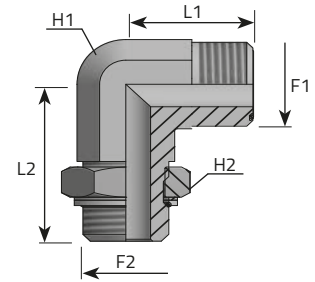

F1 ORFS

F2 Zylinder-Gasgewinde, Gas cilindrico, BSPP, Gaz cylindrique,
 Gas cilindrica

Code	Thread		Dimensions				Pressure	
	F1	F2	H1	H2	L1	L2	Bar	Psi
	in	in	mm	mm	mm	mm		
LMO06MOG02	9/16	1/8	14	14	21.5	30	350	5076
LMO09MOG04	11/16	1/4	19	19	25	37	315	4568
LMO11MOG06	13/16	3/8	22	22	28	38	250	3625
LMO13MOG08	1	1/2	27	27	33.5	48	250	3625
LMO14MOG12	1.3/16	3/4	30	36	37.5	51.5	250	3625
LMO15MOG16	1.7/16	1	36	41	41.5	58.5	200	2900
LMO21MOG20	1.11/16	1.1/4	41	50	52	60.5	200	2900
LMO32MOG24	2	1.1/2	48	55	49	64	160	2320
LMO06MOG04	9/16	1/4	14	19	21.5	35	315	4568
LMO06MOG06	9/16	3/8	19	22	23.5	38	250	3625
LMO09MOG06	11/16	3/8	19	22	25	38	250	3625
LMO09MOG08	11/16	1/2	22	27	28	48	250	3625
LMO11MOG04	13/16	1/4	22	19	28	37	315	4568
LMO11MOG08	13/16	1/2	22	27	30	48	250	3625
LMO11MOG12	13/16	3/4	27	36	31.5	51.5	250	3625
LMO13MOG04	1	1/4	27	19	33.5	42.5	315	4568
LMO13MOG06	1	3/8	27	22	33.5	42.5	250	3625
LMO13MOG12	1	3/4	27	36	33.5	51.5	250	3625

90° ADJUSTABLE ADAPTOR MALE ORFS – MALE BSPP WITH O-RING (2)

GOMITO 90° MASCHIO ORFS MASCHIO GAS CILINDRICO CON O-RING
 ADAPTATEUR ORIENTABLE COUDE 90° MÂLE ORFS- MÂLE BSPP
 ADAPTER 90° GSK – AG-ORFS/ AGR-F MIT O.R. UND HALTER
 CODO 90° ORIENTABLE MACHO ORFS – MACHO BSPP

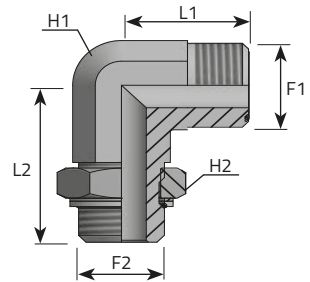

F1 ORFS

F2 Zylinder-Gasgewinde, Gas cilindrico, BSPP, Gaz cylindrique,
 Gas cilindrica

Code	Thread		Dimensions				Pressure	
	F1	F2	H1	H2	L1	L2	Bar	Psi
	in	in	mm	mm	mm	mm		
LMO13MOG16	1	1	33	41	37	58.5	200	2900
LMO14MOG04	1.3/16	1/4	30	19	37.5	43.5	315	4568
LMO14MOG08	1.3/16	1/2	30	27	37.5	49	250	3625
LMO14MOG16	1.3/16	1	33	41	42	55	200	2900
LMO15MOG04	1.7/16	1/4	36	19	41.5	52	315	4568
LMO15MOG12	1.7/16	3/4	36	36	41.5	57.5	250	3625
LMO15MOG20	1.7/16	1.1/4	41	50	50	60.5	200	2900
LMO21MOG16	1.11/16	1	41	41	52	60.5	200	2900
LMO21MOG24	1.11/16	1.1/2	48	55	43.5	67	160	2320

90° ADJUSTABLE ADAPTOR MALE ORFS – METRIC MALE WITH O-RING

GOMITO 90° MASCHIO ORFS MASCHIO METRICO CON O-RING
 ADAPTATEUR ORIENTABLE COUDE 90° MÂLE ORFS – MÂLE MÉTRIQUE
 AVEC RONDELLE D'ÉTANCHÉITÉ ET O-RING
 ADAPTER 90° GSK – AG-ORFS / AGR METRISCH MIT O.R. UND HATTER
 CODO 90° ORIENTABLE MACHO ORFS – MACHO MÉTRICO CON ARANDELA

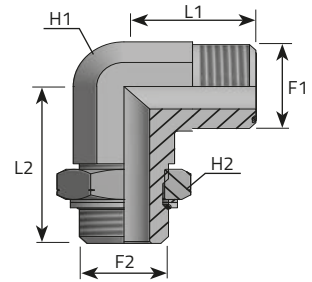

F1 ORFS

F2 Metrisch, Metrico, Metric, Métrique, Métrico

Code	Thread		Dimensions				Pressure	
	F1	F2	H1	H2	L1	L2	Bar	Psi
	in	mm	mm	mm	mm	mm		
LMO06MOM12R	9/16	12X1.5	14	17	21.5	33	315	4568
LMO09MOM14R	11/16	14X1.5	19	19	25	35.5	315	4568
LMO11MOM18R	13/16	18X1.5	22	24	28	41	315	4568
LMO13MOM22R	1	22X1.5	27	27	33.5	49	250	3625
LMO14MOM27R	1.3/16	27X2	30	32	37.5	55.5	250	3625
LMO15MOM33R	1.7/16	33X2	36	41	41.5	59.5	160	2320
LMO21MOM42R	1.11/16	42X2	41	50	52	63	160	2320
LMO32MOM48R	2	48X2	48	55	49	68.5	160	2320
LMO06MOM10R	9/16	10X1	14	14	21.5	30	315	4568
LMO09MOM16R	11/16	16X1.5	19	22	25	37.5	315	4568
LMO11MOM16R	13/16	16X1.5	22	22	28	37.5	315	4568
LMO11MOM22R	13/16	22X1.5	27	27	31.5	49	250	3625
LMO13MOM18R	1	18X1.5	27	24	33.5	47.5	315	4568
LMO13MOM27R	1	27X2	27	32	33.5	55.5	250	3625
LMO14MOM22R	1.3/16	22X1.5	30	27	37.5	49.5	250	3625
LMO14MOM33R	1.3/16	33X2	33	41	38	59.5	160	2320
LMO15MOM27R	1.7/16	27X2	36	32	41.5	59.5	250	3625
LMO15MOM42R	1.7/16	42X2	41	50	44.5	63	160	2320
LMO21MOM48R	1.11/16	48X2	48	55	52	68.5	160	2320

90° ADJUSTABLE ADAPTOR MALE ORFS – MALE UNF WITH O-RING (1)

GOMITO 90° MASCHIO ORFS MASCHIO UNF ORIENTABILE CON O-RING
 ADAPTATEUR ORIENTABLE COUDE 90° MÂLE ORFS – MÂLE UNFADAPTER
 90° GSK-AG-ORFS / AG-UNF MIT O.R.
 CODO 90° ORIENTABLE MACHO ORFS – MACHO UNF CON O-RING

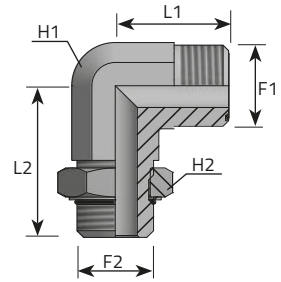

F1 ORFS

F2 UNF

Code	Thread		Dimensions				Pressure	
	F1	F2	H1	H2	L1	L2	Bar	Psi
	in	in	mm	mm	mm	mm		
LMO06MOU04	9/16	7/16	14	14	21.5	32.5	420	6091
LMO09MOU06	11/16	9/16	19	17	25	37	420	6091
LMO11MOU08	13/16	3/4	22	22	28	40.5	420	6091
LMO13MOU10	1	7/8	27	27	33.5	50	420	6091
LMO14MOU12	1.3/16	1.1/16	30	32	37.5	55	420	6091
LMO15MOU16	1.7/16	1.5/16	36	41	41.5	59.5	380	5511
LMO21MOU20	1.11/16	1.5/8	41	50	52	62	280	4060
LMO32MOU24	2	1.7/8	48	55	49	66	280	4060
LMO06MOU06	9/16	9/16	14	17	21.5	34.5	420	6091
LMO06MOU08	9/16	3/4	19	22	23.5	40.5	420	6091
LMO09MOU04	11/16	7/16	19	14	25	35	420	6091
LMO09MOU08	11/16	3/4	19	22	25	40.5	420	6091
LMO09MOU10	11/16	7/8	22	27	28	50	420	6091
LMO09MOU12	11/16	1.1/16	27	32	29.5	55	420	6091
LMO11MOU06	13/16	9/16	22	17	28	37	420	6091
LMO11MOU10	13/16	7/8	22	27	30	50	420	6091
LMO11MOU12	13/16	1.1/16	27	32	31.5	55	420	6091

90° ADJUSTABLE ADAPTOR MALE ORFS – MALE UNF WITH O-RING (2)

GOMITO 90° MASCHIO ORFS MASCHIO UNF ORIENTABILE CON O-RING
 ADAPTATEUR ORIENTABLE COUDE 90° MÂLE ORFS – MÂLE UNFADAPTER
 90° GSK-AG-ORFS / AG-UNF MIT O.R.
 CODO 90° ORIENTABLE MACHO ORFS – MACHO UNF CON O-RING

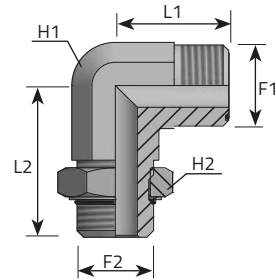

F1 ORFS

F2 UNF

Code	Thread		Dimensions				Pressure	
	F1	F2	H1	H2	L1	L2	Bar	Psi
	in	in	mm	mm	mm	mm		
LM013MOU08	1	3/4	27	22	33.5	46	420	6091
LM013MOU12	1	1.1/16	27	32	33.5	55	420	6091
LM014MOU08	1.3/16	3/4	30	22	37.5	47	420	6091
LM014MOU10	1.3/16	7/8	30	27	37.5	51	420	6091
LM014MOU16	1.3/16	1.5/16	33	41	38	59.5	380	5511
LM015MOU12	1.7/16	1.1/16	36	32	41.5	59	420	6091
LM015MOU20	1.7/16	1.5/8	41	50	44.5	62	280	4060
LM021MOU16	1.11/16	1.5/16	41	41	52	62	280	4060
LM021MOU24	1.11/16	1.7/8	48	55	52	66	280	4060
LM032MOU20	2	1.5/8	48	50	49	66	280	4060

45° ADJUSTABLE ADAPTOR MALE ORFS – MALE BSPP WITH O-RING (1)

GOMITO 45° MASCHIO ORFS MASCHIO GAS CILINDRICO ORIENTABILE
 ADAPTATEUR ORIENTABLE COUDE 45° MÂLE ORFS- MÂLE BSPP
 ADAPTER 45° GSK – AG-ORFS/ AGR-F MIT O.R. UND HALTER
 CODO 45° ORIENTABLE MACHO ORFS – MACHO BSPP

F1 ORFS

F2 Zylinder-Gasgewinde, Gas cilindrico, BSPP, Gaz cylindrique,
 Gas cilindra

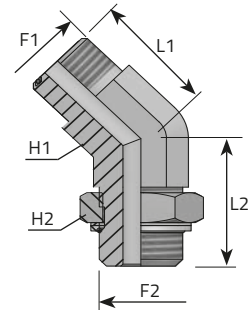

Code	Thread		Dimensions				Pressure	
	F1	F2	H1	H2	L1	L2	Bar	Psi
	in	in	mm	mm	mm	mm		
QM006MOG02	9/16	1/8	14	14	16	27.5	350	5076
QM009MOG04	11/16	1/4	19	19	19	32.5	315	4568
QM011MOG06	13/16	3/8	22	22	20.5	33.5	250	3625
QM013MOG08	1	1/2	27	27	23.5	43	250	3625
QM014MOG12	1.3/16	3/4	30	36	26	46.5	250	3625
QM015MOG16	1.7/16	1	36	41	30	51	200	2900
QM021MOG20	1.11/16	1.1/4	41	50	32	52.5	200	2900
QM032MOG24	2	1.1/2	48	55	37	52.5	160	2320
QM006MOG04	9/16	1/4	14	19	16	31.5	315	4568
QM006MOG06	9/16	3/8	19	22	17.5	33.5	250	3625
QM009MOG06	11/16	3/8	19	22	19	33.5	250	3625
QM009MOG08	11/16	1/2	22	27	20	43	250	3625
QM011MOG04	13/16	1/4	22	19	20.5	32.5	315	4568
QM011MOG08	13/16	1/2	22	27	21	43	250	3625
QM011MOG12	13/16	3/4	27	36	21.5	46.5	250	3625
QM013MOG04	1	1/4	27	19	23.5	36	315	4568
QM013MOG06	1	3/8	27	22	23.5	37	250	3625
QM013MOG12	1	3/4	27	36	23.5	46.5	250	3625

45° ADJUSTABLE ADAPTOR MALE ORFS – MALE BSPP WITH O-RING (2)

GOMITO 45° MASCHIO ORFS MASCHIO GAS CILINDRICO CON O-RING
 ADAPTATEUR ORIENTABLE COUDE 45° MÂLE ORFS– MÂLE BSPP
 ADAPTER 45° GSK – AG-ORFS/ AGR-F MIT O.R. UND HALTER
 CODO 45° ORIENTABLE MACHO ORFS – MACHO BSPP

F1 ORFS

F2 Zylinder-Gasgewinde, Gas cilindrico, BSPP, Gaz cylindrique,
 Gas cilindrica

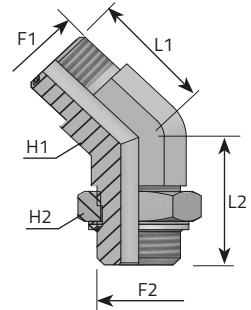

Code	Thread		Dimensions				Pressure	
	F1	F2	H1	H2	L1	L2	Bar	Psi
	in	in	mm	mm	mm	mm		
QMO13MOG16	1	1	33	41	28.5	51	200	2900
QMO14MOG04	1.3/16	1/4	30	19	26	40.5	315	4568
QMO14MOG08	1.3/16	1/2	30	27	26	44.5	250	3625
QMO14MOG16	1.3/16	1	33	41	29.5	51	200	2900
QMO15MOG04	1.7/16	1/4	36	19	30	41	315	4568
QMO15MOG12	1.7/16	3/4	36	36	30	47	250	3625
QMO15MOG20	1.7/16	1.1/4	41	50	32	52.5	200	2900
QMO21MOG16	1.11/16	1	41	41	32	52.5	200	2900
QMO21MOG24	1.11/16	1.1/2	48	55	35.5	52.5	160	2320

45° ADJUSTABLE ADAPTOR MALE ORFS – METRIC MALE WITH O-RING

GOMITO 45° MASCHIO ORFS MASCHIO METRICO CON O-RING
 ADAPTATEUR ORIENTABLE COUDE 45° MÂLE ORFS – MÂLE MÉTRIQUE
 AVEC RONDELLE D'ÉTANCHÉITÉ ET O-RING
 ADAPTER 45° GSK – AG-ORFS / AGR METRISCH MIT O.R. UND HATTER
 CODO 45° ORIENTABLE MACHO ORFS – MACHO MÉTRICO CON ARANDELA

F1 ORFS

F2 Metrisch, Metrico, Metric, Métrique, Métrico

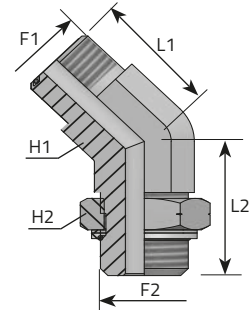

Code	Thread		Dimensions				Pressure	
	F1	F2	H1	H2	L1	L2	Bar	Psi
	in	mm	mm	mm	mm	mm		
QMO06MOM12R	9/16	12X1.5	14	17	16	30	315	4568
QMO09MOM14R	11/16	14X1.5	19	19	19	31	315	4568
QMO11MOM18R	13/16	18X1.5	22	24	20.5	36.5	315	4568
QMO13MOM22R	1	22X1.5	27	27	23.5	44	250	3625
QMO14MOM27R	1.3/16	27X2	30	32	26	50	250	3625
QMO15MOM33R	1.7/16	33X2	36	41	30	52.5	250	3625
QMO21MOM42R	1.11/16	42X2	41	50	32	54	160	2320
QMO32MOM48R	2	48X2	48	55	37	56.5	160	2320
QMO06MOM10R	9/16	10X1	14	14	16	27	315	4568
QMO09MOM16R	11/16	16X1.5	19	22	19	33	315	4568
QMO11MOM16R	13/16	16X1.5	22	22	20.5	33	315	4568
QMO11MOM22R	13/16	22X1.5	27	27	21.5	44	250	3625
QMO13MOM18R	1	18X1.5	27	24	23.5	42.5	315	4568
QMO13MOM27R	1	27X2	27	32	23.5	50	250	3625
QMO14MOM22R	1.3/16	22X1.5	30	27	26	44	250	3625
QMO14MOM33R	1.3/16	33X2	33	41	29.5	52.5	160	2320
QMO15MOM27R	1.7/16	27X2	36	32	30	52.5	250	3625
QMO15MOM42R	1.7/16	42X2	41	50	32	54	160	2320
QMO21MOM48R	1.11/16	48X2	48	55	35.5	56.5	160	2320

45° ADJUSTABLE ADAPTOR MALE ORFS – MALE UNF WITH O-RING (1)

GOMITO 45° MASCHIO ORFS MASCHIO ORIENTABILE UNF CON O-RING
 ADAPTATEUR ORIENTABLE COUDE 45° MÂLE ORFS – MÂLE UNF
 ADAPTER 45° GSK-AG-ORFS / AG-UNF MIT O.R.
 CODO 45° ORIENTABLE MACHO ORFS – MACHO UNF CON O-RING

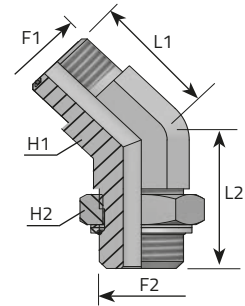

F1 ORFS

F2 UNF

Code	Thread		Dimensions				Pressure	
	F1 in	F2 in	H1 mm	H2 mm	L1 mm	L2 mm	Bar	Psi
QMO06MOU04	9/16	7/16	14	14	16	30	420	6091
QMO09MOU06	11/16	9/16	19	17	19	33	420	6091
QMO11MOU08	13/16	3/4	22	22	20.5	36.5	420	6091
QMO13MOU10	1	7/8	27	27	23.5	45	420	6091
QMO14MOU12	1.3/16	1.1/16	30	32	26	50	420	6091
QMO15MOU16	1.7/16	1.5/16	36	41	30	52.5	380	5511
QMO21MOU20	1.11/16	1.5/8	41	50	32	53.5	280	4060
QMO32MOU24	2	1.7/8	48	55	37	53.5	280	4060
QMO06MOU06	9/16	9/16	14	17	16	33	420	6091
QMO06MOU08	9/16	3/4	19	22	17.5	36.5	420	6091
QMO09MOU04	11/16	7/16	19	14	19	31	420	6091
QMO09MOU08	11/16	3/4	19	22	19	36.5	420	6091
QMO09MOU10	11/16	7/8	22	27	20	45	420	6091
QMO09MOU12	11/16	1.1/16	27	32	19.5	50	420	6091
QMO11MOU06	13/16	9/16	22	17	20.5	32.5	420	6091
QMO11MOU10	13/16	7/8	22	27	21	45	420	6091
QMO11MOU12	13/16	1.1/16	27	32	21.5	50	420	6091

45° ADJUSTABLE ADAPTOR MALE ORFS – MALE UNF WITH O-RING (2)

GOMITO 45° MASCHIO ORFS MASCHIO ORIENTABILE UNF CON O-RING
 ADAPTATEUR ORIENTABLE COUDE 45° MÂLE ORFS – MÂLE UNF
 ADAPTER 45° GSK-AG-ORFS / AG-UNF MIT O.R.
 CODO 45° ORIENTABLE MACHO ORFS – MACHO UNF CON O-RING

F1 ORFS

F2 UNF

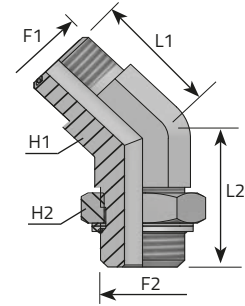

Code	Thread		Dimensions				Pressure	
	F1	F2	H1	H2	L1	L2	Bar	Psi
	in	in	mm	mm	mm	mm		
QMO13MOU08	1	3/4	27	22	23.5	40.5	420	6091
QMO13MOU12	1	1.1/16	27	32	23.5	50	420	6091
QMO14MOU08	1.3/16	3/4	30	22	26	40.5	420	6091
QMO14MOU10	1.3/16	7/8	30	27	26	46	420	6091
QMO14MOU16	1.3/16	1.5/16	33	41	29.5	52.5	380	5511
QMO15MOU12	1.7/16	1.1/16	36	32	30	51.5	420	6091
QMO15MOU20	1.7/16	1.5/8	41	50	32	53.5	280	4060
QMO21MOU16	1.11/16	1.5/16	41	41	32	53.5	280	4060
QMO21MOU24	1.11/16	1.7/8	48	55	35.5	53.5	280	4060
QMO32MOU20	2	1.5/8	48	50	37	53.5	280	4060

RUN TEE MALE ORFS - ADJUSTABLE MALE BSPP WITH WITH O-RING (1)

RACCORDO A "T" MASCHIO ORFS MASCHIO GAS CILINDRICO ORIENTABILE
 ADAPTOR TÉR EVERSÉ MÂLE ORFS - MÂLE ORIENTABLE BSPP
 ADAPTER T-STÜCK 2XAG-ORFS / AGR- F MIT O.R. UND HALTER
 ADAPTADOR EN L MACHO ORFS - MACHO ORIENTABLE BSPP

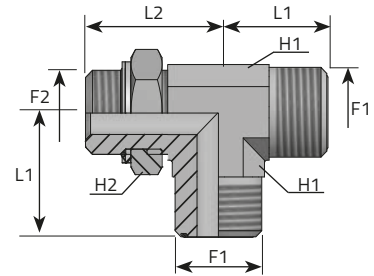

F1 ORFS

F2 Zylinder-Gasgewinde, Gas cilindrico, BSPP, Gaz cylindrique,
 Gas cilíndrica

Code	Thread		Dimensions				Pressure	
	F1	F2	H1	H2	L1	L2	Bar	Psi
	in	in	mm	mm	mm	mm		
TM006MOG02B	9/16	1/8	14	14	21.5	30	350	5076
TM009MOG04B	11/16	1/4	19	19	25	37	315	4568
TM011MOG06B	13/16	3/8	22	22	28	38	250	3625
TM013MOG08B	1	1/2	27	27	33.5	48	250	3625
TM014MOG12B	1.3/16	3/4	30	36	37.5	51.5	250	3625
TM015MOG16B	1.7/16	1	36	41	41.5	58.5	200	2900
TM021MOG20B	1.11/16	1.1/4	41	50	44.5	60.5	200	2900
TM032MOG24B	2	1.1/2	48	55	49	64	160	2320
TM006MOG04B	9/16	1/4	14	19	21.5	35	315	4568
TM006MOG06B	9/16	3/8	19	22	23.5	38	250	3625
TM009MOG06B	11/16	3/8	19	22	25	38	250	3625
TM009MOG08B	11/16	1/2	22	27	28	48	250	3625
TM011MOG04B	13/16	1/4	22	19	28	37	315	4568
TM011MOG08B	13/16	1/2	22	27	30	48	250	3625
TM011MOG12B	13/16	3/4	27	36	31.5	51.5	250	3625
TM013MOG04B	1	1/4	27	19	33.5	42.5	315	4568
TM013MOG06B	1	3/8	27	22	33.5	42.5	250	3625
TM013MOG12B	1	3/4	27	36	33.5	51.5	250	3625

RUN TEE MALE ORFS - ADJUSTABLE MALE BSPP WITH WITH O-RING (2)

RACCORDO A "T" MASCHIO ORFS MASCHIO GAS CILINDRICO ORIENTABILE
 ADAPTOR TÉR EVERSE MÂLE ORFS - MÂLE ORIENTABLE BSPP
 ADAPTER T-STUCK 2XAG-ORFS / AGR- F MIT O.R. UND HALTER
 ADAPTADOR EN L MACHO ORFS - MACHO ORIENTABLE BSPP

F1 ORFS

F2 Zylinder-Gasgewinde, Gas cilindrico, BSPP, Gaz cylindrique,
 Gas cilindrica

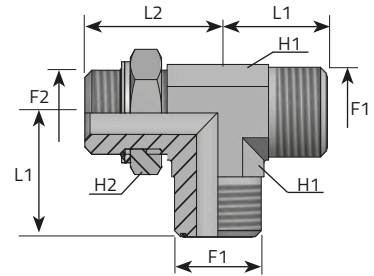

Code	Thread		Dimensions				Pressure	
	F1	F2	H1	H2	L1	L2	Bar	Psi
	in	in	mm	mm	mm	mm		
TM013MOG16B	1	1	33	41	37	58.5	200	2900
TM014MOG04B	1.3/16	1/4	30	19	37.5	43.5	315	4568
TM014MOG08B	1.3/16	1/2	30	27	37.5	49	250	3625
TM014MOG16B	1.3/16	1	33	41	42	54	200	2900
TM015MOG04B	1.7/16	1/4	36	19	41.5	52	315	4568
TM015MOG12B	1.7/16	3/4	36	36	41.5	57.5	250	3625
TM015MOG20B	1.7/16	1.1/4	41	50	44.5	60.5	200	2900
TM021MOG16B	1.11/16	1	41	41	44.5	60.5	200	2900
TM021MOG24B	1.11/16	1.1/2	48	55	48.5	64	160	2320

RUN TEE MALE ORFS - ADJUSTABLE METRIC MALE WITH O-RING

RACCORDO A "T" MASCHIO ORFS MASCHIO METRICO ORIENTABILE
 ADAPTOR TÉ RENVERSÉ MÂLE ORFS - MÂLE ORIENTABLE MÉTRIQUE
 ADAPTER T-STÜCK 2XAG-ORFS/ AG-METRISCH MIT O.R. UND HALTER
 ADAPTADOR EN L MACHO ORFS - MACHO MÉTRICO ORIENTABLE

F1 ORFS

F2 Metrisch, Metrico, Metric, Métrique, Métrico

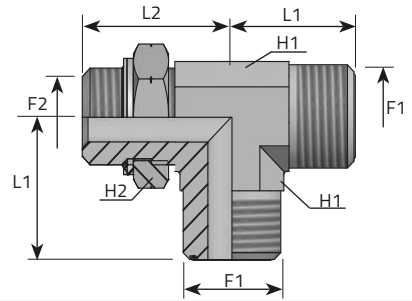

Code	Thread		Dimensions				Pressure	
	F1	F2	H1	H2	L1	L2	Bar	Psi
	in	mm	mm	mm	mm	mm		
TM006MOM12RB	9/16	12X1.5	14	17	21.5	33	315	4568
TM009MOM14RB	11/16	14X1.5	19	19	25	35.5	315	4568
TM011MOM18RB	13/16	18X1.5	22	24	28	41	315	4568
TM013MOM22RB	1	22X1.5	27	27	33.5	49	250	3625
TM014MOM27RB	1.3/16	27X2	30	32	37.5	55.5	250	3625
TM015MOM33RB	1.7/16	33X2	36	41	41.5	59.5	160	2320
TM021MOM42RB	1.11/16	42X2	41	50	44.5	63	160	2320
TM032MOM48RB	2	48X2	48	55	49	68.5	160	2320
TM006MOM10RB	9/16	10X1	14	14	21.5	30	315	4568
TM009MOM16RB	11/16	16X1.5	19	22	25	37.5	315	4568
TM011MOM16RB	13/16	16X1.5	22	22	28	37.5	315	4568
TM011MOM22RB	13/16	22X1.5	27	27	31.5	49	250	3625
TM013MOM18RB	1	18X1.5	27	24	33.5	47.5	315	4568
TM013MOM27RB	1	27X2	27	32	33.5	55.5	250	3625
TM014MOM22RB	1.3/16	22X1.5	30	27	37.5	49.5	250	3625
TM014MOM33RB	1.3/16	33X2	33	41	38	59.5	160	2320
TM015MOM27RB	1.7/16	27X2	36	32	41.5	59.5	250	3625
TM015MOM42RB	1.7/16	42X2	41	50	44.5	63	160	2320
TM021MOM48RB	1.11/16	48X2	48	55	48.5	68.5	160	2320

RUN TEE MALE ORFS - MALE UNF WITH O-RING (1)

RACCORDO A "T" MASCHIO ORFS MASCHIO UNF CON O-RING AL BRACCIO
 RENVERSÉ MÂLE ORFS - MÂLE UNF AVEC O-RING
 ADAPTER T-STÜCK 2 X AG-ORFS / 1 X AG- UNF MIT O.R.
 ADAPTADOR EN L MACHO ORFS - MACHO UNF CON O-RING

F1 ORFS

F2 UNF

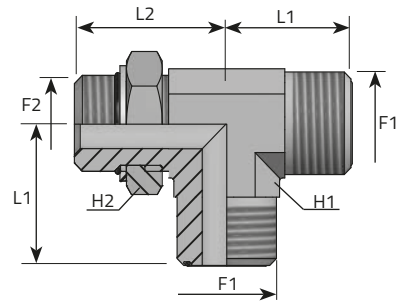

Code	Thread		Dimensions				Pressure	
	F1	F2	H1	H2	L1	L2	Bar	Psi
	in	in	mm	mm	mm	mm		
TMO06MOU04B	9/16	7/16	14	14	21.5	32.5	420	6091
TMO09MOU06B	11/16	9/16	19	17	25	37	420	6091
TMO11MOU08B	13/16	3/4	22	22	28	40.5	420	6091
TMO13MOU10B	1	7/8	27	27	33.5	50	420	6091
TMO14MOU12B	1.3/16	1.1/16	30	32	37.5	55	420	6091
TMO15MOU16B	1.7/16	1.5/16	36	41	41.5	59.5	380	5511
TMO21MOU20B	1.11/16	1.5/8	41	50	44.5	62	280	4060
TMO32MOU24B	2	1.7/8	48	55	49	66	280	4060
TMO06MOU06B	9/16	9/16	14	17	21.5	34.5	420	6091
TMO06MOG08B	9/16	3/4	19	22	23.5	40.5	420	6091
TMO09MOU04B	11/16	7/16	19	14	25	35	420	6091
TMO09MOU08B	11/16	3/4	19	22	25	40.5	420	6091
TMO09MOU10B	11/16	7/8	22	27	28	50	420	6091
TMO09MOU12B	11/16	1.1/16	27	32	29.5	55	420	6091
TMO11MOU06B	13/16	9/16	22	17	28	37	420	6091
TMO11MOU10B	13/16	7/8	22	27	30	50	420	6091
TMO11MOU12B	13/16	1.1/16	27	32	31.5	55	420	6091

RUN TEE MALE ORFS - MALE UNF WITH O-RING (2)

RACCORDO A "T" MASCHIO ORFS MASCHIO UNF CON O-RING AL BRACCIO
 RENVERSÉ MÂLE ORFS - MÂLE UNF AVEC O-RING
 ADAPTER T-STÜCK 2 X AG-ORFS / 1 X AG- UNF MIT O.R.
 ADAPTADOR EN L MACHO ORFS - MACHO UNF CON O-RING

F1 ORFS

F2 UNF

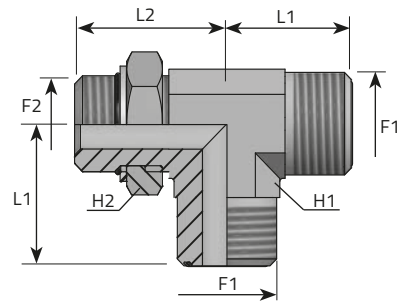

Code	Thread		Dimensions				Pressure	
	F1	F2	H1	H2	L1	L2	Bar	Psi
	in	in	mm	mm	mm	mm		
TM013MOU08B	1	3/4	27	22	33.5	46	420	6091
TM013MOU12B	1	1.1/16	27	32	33.5	55	420	6091
TM014MOU08B	1.3/16	3/4	30	22	37.5	47	420	6091
TM014MOU10B	1.3/16	7/8	30	27	37.5	51	420	6091
TM014MOU16B	1.3/16	1.5/16	33	41	38	59.5	380	5511
TM015MOU12B	1.7/16	1.1/16	36	32	41.5	59	420	6091
TM015MOU20B	1.7/16	1.5/8	41	50	44.5	62	280	4060
TM021MOU16B	1.11/16	1.5/16	41	41	44.5	62	280	4060
TM021MOU24B	1.11/16	1.7/8	48	55	48.5	66	280	4060
TM032MOU20B	2	1.5/8	48	50	49	66	280	4060

BRANCH TEE MALE ORFS - ADJUSTABLE MALE BSPP WITH O-RING (1)

RACCORDO A "T" MASCHIO ORFS MASCHIO GAS CILINDRICO ORIENTABILE
 ADAPTOR TÊ MÂLE ORFS - MÂLE ORIENTABLE
 ADAPTER T-STUCK 2XAG-ORFS / 1 X AGR- F MIT O.R. UND HALTER
 ADAPTADOR TE MACHO ORFS - MACHO ORIENTABLE BSPP

F1 ORFS

F2 Zylinder-Gasgewinde, Gas cilindrico, BSPP, Gaz cylindrique,
 Gas cilindra

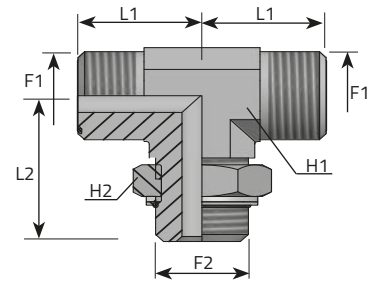

Code	Thread		Dimensions				Pressure	
	F1	F2	H1	H2	L1	L2	Bar	Psi
	in	in	mm	mm	mm	mm		
TMO06MOG02P	9/16	1/8	14	14	21.5	30	350	5076
TMO09MOG04P	11/16	1/4	19	19	25	37	315	4568
TMO11MOG06P	13/16	3/8	22	22	28	38	250	3625
TMO13MOG08P	1	1/2	27	27	33.5	48	250	3625
TMO14MOG12P	1.3/16	3/4	30	36	37.5	51.5	250	3625
TMO15MOG16P	1.7/16	1	36	41	41.5	58.5	200	2900
TMO21MOG20P	1.11/16	1.1/4	41	50	44.5	60.5	200	2900
TMO32MOG24P	2	1.1/2	48	55	49	64	160	2320
TMO06MOG04P	9/16	1/4	14	19	21.5	35	315	4568
TMO06MOG06P	9/16	3/8	19	22	23.5	38	250	3625
TMO09MOG06P	11/16	3/8	19	22	25	38	250	3625
TMO09MOG08P	11/16	1/2	22	27	28	48	250	3625
TMO11MOG04P	13/16	1/4	22	19	28	37	315	4568
TMO11MOG08P	13/16	1/2	22	27	30	48	250	3625
TMO11MOG12P	13/16	3/4	27	36	31.5	51.5	250	3625
TMO13MOG04P	1	1/4	27	19	33.5	42.5	315	4568
TMO13MOG06P	1	3/8	27	22	33.5	42.5	250	3625
TMO13MOG12P	1	3/4	27	36	33.5	51.5	250	3625

BRANCH TEE MALE ORFS - ADJUSTABLE MALE BSPP WITH O-RING (2)

RACCORDO A "T" MASCHIO ORFS MASCHIO GAS CILINDRICO ORIENTABILE
 ADAPTOR TÊ MÂLE ORFS - MÂLE ORIENTABLE
 ADAPTER T-STÜCK 2XAG-ORFS / 1 X AGR- F MIT O.R. UND HALTER
 ADAPTADOR TE MACHO ORFS - MACHO ORIENTABLE BSPP

F1 ORFS

F2 Zylinder-Gasgewinde, Gas cilindrico, BSPP, Gaz cylindrique,
 Gas cilíndrica

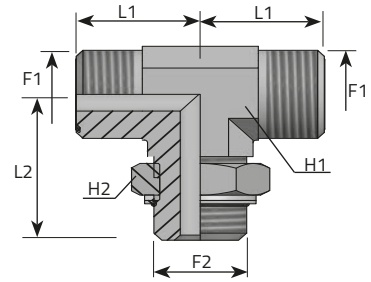

Code	Thread		Dimensions				Pressure	
	F1	F2	H1	H2	L1	L2	Bar	Psi
	in	in	mm	mm	mm	mm		
TMO13MOG16P	1	1	33	41	37	58.5	200	2900
TMO14MOG04P	1.3/16	1/4	30	19	37.5	43.5	315	4568
TMO14MOG08P	1.3/16	1/2	30	27	37.5	49	250	3625
TMO14MOG16P	1.3/16	1	33	41	42	54	200	2900
TMO15MOG04P	1.7/16	1/4	36	19	41.5	52	315	4568
TMO15MOG12P	1.7/16	3/4	36	36	41.5	57.5	250	3625
TMO15MOG20P	1.7/16	1.1/4	41	50	44.5	60.5	200	2900
TMO21MOG16P	1.11/16	1	41	41	44.5	60.5	200	2900
TMO21MOG24P	1.11/16	1.1/2	48	55	48.5	64	160	2320

BRANCH TEE MALE ORFS - ADJUSTABLE METRIC MALE WITH O-RING

"T" MASCHIO ORFS MASCHIO METRICO ORIENTABILE AL PIEDE
 ADAPTATEUR TÉ RENVERSÉ MÂLE ORFS - MÂLE MÉTRIQUE
 ADAPTER T-STUCK 2XAG-ORFS / 1 XAG-METRISCH MIT O.R. UND HALTER
 ADAPTADOR MACHO ORFS - MACHO MÉTRICO ORIENTABLE

F1 ORFS

F2 Metrisch, Metrico, Metric, Métrique, Métrico

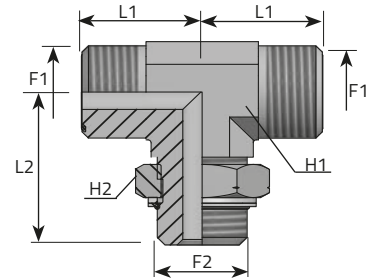

Code	Thread		Dimensions				Pressure	
	F1	F2	H1	H2	L1	L2	Bar	Psi
	in	mm	mm	mm	mm	mm		
TMO06MOM12RP	9/16	12X1.5	14	17	21.5	33	315	4568
TMO09MOM14RP	11/16	14X1.5	19	19	25	35.5	315	4568
TMO11MOM18RP	13/16	18X1.5	22	24	28	41	315	4568
TMO13MOM22RP	1	22X1.5	27	27	33.5	49	250	3625
TMO14MOM27RP	1.3/16	27X2	30	32	37.5	55.5	250	3625
TMO15MOM33RP	1.7/16	33X2	36	41	41.5	59.5	160	2320
TMO21MOM42RP	1.11/16	42X2	41	50	44.5	63	160	2320
TMO32MOM48RP	2	48X2	48	55	49	68.5	160	2320
TMO06MOM10RP	9/16	10X1	14	14	21.5	30	315	4568
TMO09MOM16RP	11/16	16X1.5	19	22	25	37.5	315	4568
TMO11MOM16RP	13/16	16X1.5	22	22	28	37.5	315	4568
TMO11MOM22RP	13/16	22X1.5	27	27	31.5	49	250	3625
TMO13MOM18RP	1	18X1.5	27	24	33.5	47.5	315	4568
TMO13MOM27RP	1	27X2	27	32	33.5	55.5	250	3625
TMO14MOM22RP	1.3/16	22X1.5	30	27	37.5	49.5	250	3625
TMO14MOM33RP	1.3/16	33X2	33	41	38	59.5	160	2320
TMO15MOM27RP	1.7/16	27X2	36	32	41.5	59.5	250	3625
TMO15MOM42RP	1.7/16	42X2	41	50	44.5	63	160	2320
TMO21MOM48RP	1.11/16	48X2	48	55	48.5	68.5	160	2320

ADJUSTABLE BRANCH TEE MALE ORFS - MALE UNF WITH O-RING (1)

RACCORDO A "T" MASCHIO ORFS MASCHIO UNF CON O-RING AL PIEDE
 RENVERSÉ MÂLE ORFS - MÂLE UNF AVEC O-RING
 ADAPTER T-STÜCK 2 X AG-ORFS / 1 X AG- UNF MIT O.R.
 ADAPTADOR EN L MACHO ORFS - MACHO UNF CON O-RING

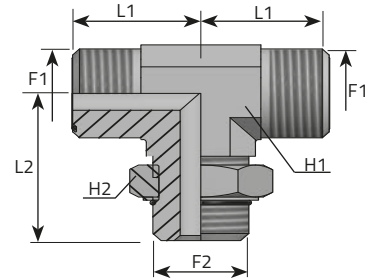

F1 ORFS

F2 UNF

Code	Thread		Dimensions				Pressure	
	F1	F2	H1	H2	L1	L2	Bar	Psi
	in	in	mm	mm	mm	mm		
TM006MOU04P	9/16	7/16	14	14	21.5	32.5	420	6091
TM009MOU06P	11/16	9/16	19	17	25	37	420	6091
TM011MOU08P	13/16	3/4	22	22	28	40.5	420	6091
TM013MOU10P	1	7/8	27	27	33.5	50	420	6091
TM014MOU12P	1.3/16	1.1/16	30	32	37.5	55	420	6091
TM015MOU16P	1.7/16	1.5/16	36	41	41.5	59.5	380	5511
TM021MOU20P	1.11/16	1.5/8	41	50	44.5	62	280	4060
TM032MOU24P	2	1.7/8	48	55	49	66	280	4060
TM006MOU06P	9/16	9/16	14	17	21.5	34.5	420	6091
TM006MOU08P	9/16	3/4	19	22	23.5	40.5	420	6091
TM009MOU04P	11/16	7/16	19	14	25	35	420	6091
TM009MOU08P	11/16	3/4	19	22	25	40.5	420	6091
TM009MOU10P	11/16	7/8	22	27	28	50	420	6091
TM009MOU12P	11/16	1.1/16	27	32	29.5	55	420	6091
TM011MOU06P	13/16	9/16	22	17	28	37	420	6091
TM011MOU10P	13/16	7/8	22	27	30	50	420	6091
TM011MOU12P	13/16	1.1/16	27	32	31.5	55	420	6091

ADJUSTABLE BRANCH TEE MALE ORFS - MALE UNF WITH O-RING (2)

RACCORDO A "T" MASCHIO ORFS MASCHIO UNF CON O-RING AL PIEDE
 RENVERSÉ MÂLE ORFS - MÂLE UNF AVEC O-RING
 ADAPTER T-STÜCK 2 X AG-ORFS / 1 X AG- UNF MIT O.R.
 ADAPTADOR EN L MACHO ORFS - MACHO UNF CON O-RING

F1 ORFS

F2 UNF

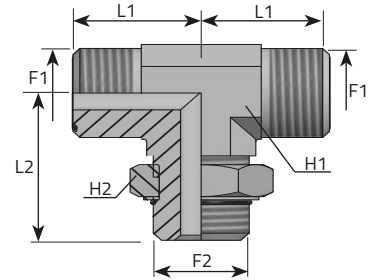

Code	Thread		Dimensions				Pressure	
	F1	F2	H1	H2	L1	L1	Bar	Psi
	in	in	mm	mm	mm	mm		
TMO13MOU08P	1	3/4	27	22	33.5	46	420	6091
TMO13MOU12P	1	1.1/16	27	32	33.5	55	420	6091
TMO14MOU08P	1.3/16	3/4	30	22	37.5	47	420	6091
TMO14MOU10P	1.3/16	7/8	30	27	37.5	51	420	6091
TMO14MOU16P	1.3/16	1.5/16	33	41	38	59.5	380	5511
TMO15MOU12P	1.7/16	1.1/16	36	32	41.5	59	420	6091
TMO15MOU20P	1.7/16	1.5/8	41	50	44.5	62	280	4060
TMO21MOU16P	1.11/16	1.5/16	41	41	44.5	62	280	4060
TMO21MOU24P	1.11/16	1.7/8	48	55	48.5	66	280	4060
TMO32MOU20P	2	1.5/8	48	50	49	66	280	4060

90° ADAPTOR FEMALE ORFS – ADJUSTABLE MALE BSPP WITH O-RING

GOMITO A 90° FEMMINA ORFS MASCHIO GAS CILINDRICO ORIENTABILE
 ADAPTATEUR COUDE 90° FEMELLE ORFS – MÂLE ORIENTABLE BSPP
 ADAPTER 90° IG-ORFS / AG-BSPP MIT O.R UND HALTER
 CODO 90° HEMBRA ORFS – MACHO ORIENTABLE BSPP

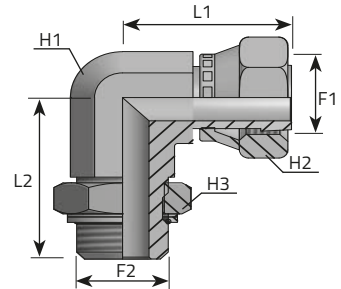

F1 ORFS

F2 Zylinder-Gasgewinde, Gas cilindrico, BSPP, Gaz cylindrique,
 Gas cilíndrica

Code	Thread		Dimensions						Pressure	
	F1	F2	H1	H2	H3	L1	L2	Bar	Psi	
	in	in	mm	mm	mm	mm	mm			
LFG006MOG02	9/16	1/8	14	17	14	26.5	30	350	5076	
LFG009MOG04	11/16	1/4	19	22	19	29	37	315	4568	
LFG011MOG06	13/16	3/8	22	24	22	38	38	250	3625	
LFG013MOG08	1	1/2	27	30	27	41	48	250	3625	
LFG014MOG12	1.3/16	3/4	30	36	36	46.5	51.5	250	3625	
LFG015MOG16	1.7/16	1	36	41	41	53.5	58.5	200	2900	
LFG021MOG20	1.11/16	1.1/4	41	50	50	58	60.5	200	2900	
LFG032MOG24	2	1.1/2	48	60	55	61	64	160	2320	

90° ADAPTOR FEMALE ORFS – ADJUSTABLE METRIC MALE WITH O-RING

GOMITO A 90° FEMMINA ORFS MASCHIO METRICO ORIENTABILE
 ADAPTATEUR COUDE 90° FEMELLE ORFS – MÂLE ORIENTABLE MÉTRIQUE
 ADAPTER 90° IG-ORFS / AG-METRISH MIT O.R UND HALTER
 CODO 90° HEMBRA ORFS – MACHO ORIENTABLE MÉTRICO

F1 ORFS

F2 Metrisch, Metrico, Metric, Métrique, Métrico

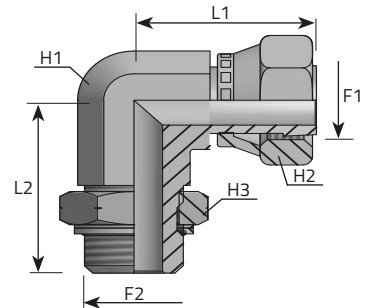

Code	Thread		Dimensions					Pressure	
	F1	F2	H1	H2	H3	L1	L2	Bar	Psi
	in	mm	mm	mm	mm	mm	mm		
LFG006MOM12R	9/16	12X1.5	14	17	17	26.5	33	315	4568
LFG009MOM14R	11/16	14X1.5	19	22	19	29	35.5	315	4568
LFG011MOM18R	13/16	18X1.5	22	24	24	38	41	315	4568
LFG013MOM22R	1	22X1.5	27	30	27	41	49	250	3625
LFG014MOM27R	1.3/16	27X2	30	36	32	46.5	55.5	250	3625
LFG015MOM33R	1.7/16	33X2	36	41	41	53.5	59.5	160	2320
LFG021MOM42R	1.11/16	42X2	41	50	50	58	63	160	2320
LFG032MOM48R	2	48X2	48	60	55	61	68.5	160	2320

90° ADAPTOR FEMALE ORFS – MALE UNF WITH O-RING

GOMITO A 90° FEMMINA ORFS MASCHIO UNF CON O-RING
 ADAPTATEUR COUDE 90° FEMELLE ORFS – MÂLE UNF AVEC O-RING
 ADAPTER 90° IG-ORFS / AG-UNF MIT O.R.
 CODO 90° HEMBRA ORFS – MACHO UNF CON O-RING

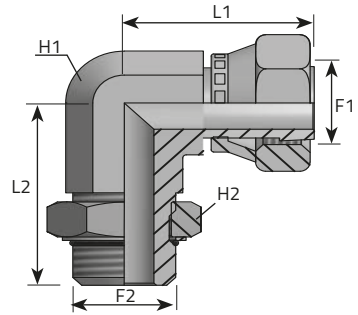

F1 ORFS

F2 UNF

Code	Thread		Dimensions					Pressure	
	F1	F2	H1	H2	H3	L1	L2	Bar	Psi
	in	in	mm	mm	mm	mm	mm		
LFG006MOU04	9/16	7/16	14	17	14	26.5	32.5	420	6091
LFG009MOU06	11/16	9/16	19	22	17	29	37	420	6091
LFG011MOU08	13/16	3/4	22	24	22	38	40.5	420	6091
LFG013MOU10	1	7/8	27	30	27	41	50	420	6091
LFG014MOU12	1.3/16	1.1/16	30	36	32	46.5	55	420	6091
LFG015MOU16	1.7/16	1.5/16	36	41	41	53.5	59.5	380	5511
LFG021MOU20	1.11/16	1.5/8	41	50	50	58	62	280	4060
LFG032MOU24	2	1.7/8	48	60	55	61	66	280	4060

MALE PLUG UNF/UN-2A

TAPPO MASCHIO FILETTO UNF/UN-2A
 BOUCHON MÂLE UNF/UN-2A
 VERSCHLUSSKAPPE - UNF/UN-2A
 TAPÓN MACHO UNF/UN

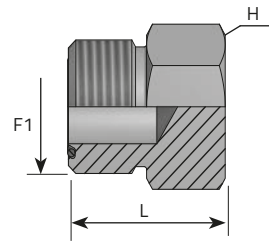

F1 UNF

Code	Thread	Dimensions		Pressure	
		H1	L1	Bar	Psi
	F1				
	in	mm	mm		
ATM006	9/16	17	16.5	630	9136
ATM009	11/16	19	19	630	9136
ATM011	13/16	22	22	630	9136
ATM013	1	27	26	420	6091
ATM014	1.3/16	32	27.5	420	6091
ATM015	1.7/16	41	28	420	6091
ATM021	1.11/16	46	28	280	4060
ATM032	2	55	28	280	4060

SWIVEL FEMALE PLUG UNF/UN-2B

TAPPO FEMMINA CON DADO GIREVOLE FILETTO UNF/UN-2B
 BOUCHON FEMELLE TOURNANTE UNF/UN-2B
 VERSCHLUSSKAPPE UNF/UN-2B
 TAPÓN HEMBRA GIRATORIA UNF/UN-2B

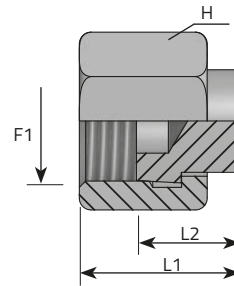

F1 UNF

Code	Thread	Dimensions			Pressure	
		H	L1	L2	Bar	Psi
	F1					
	in	mm	mm	mm	Bar	Psi
ATFG006	9/16	17	16.5	8.5	630	9136
ATFG009	11/16	22	18	9.5	630	9136
ATFG011	13/16	24	22	12	630	9136
ATFG013	1	30	24.5	12	420	6091
ATFG014	1.3/16	36	27	13.5	420	6091
ATFG015	1.7/16	41	28.5	15	420	6091
ATFG021	1.11/16	50	28.5	15	280	4060
ATFG032	2	60	28.5	15	280	4060

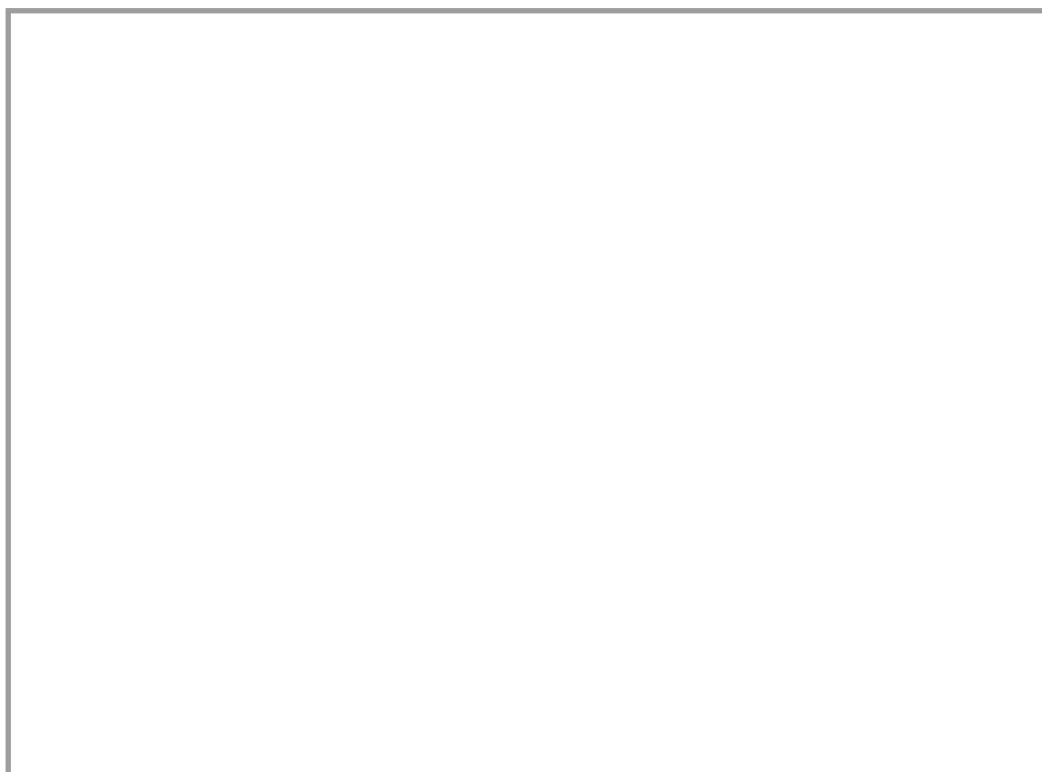

ORFS J1453 0-2020 EU

Data reported in this catalogue are not binding.

Vitillo S.p.a. reserves the right to change specifications without notice.

I dati riportati nella seguente pubblicazione non sono vincolanti.

Vitillo S.p.a. si riserva di apportare modifiche senza preavviso.

Les données exposées dans ce catalogue ne sont pas contraignantes.

Vitillo s.p.a se réserve le droit d'apporter des modifications sans aucun préavis.

Die vorliegenden Angaben sind nicht bindend.

Vitillo S.p.a. behält sich technische Änderungen vor ohne Mitteilung.

Los datos referidos en la presente publicación son indicativos.

Vitillo S.p.a. se reserva el derecho de modificar las especificaciones sin aviso previo.